

20

Years of Excellence
1988-2008



Georgia
Hardwoods Inc

Lumber

Plywood

Doors

Drawers

Mouldings

Range Hoods

Carvings



2008
Product Catalog



Celebrating 20 years of excellence as a leading distributor of quality plywood, lumber and hardware products. Established in 1988, we have partnered with some of the most well known and respected suppliers in the industry to provide you with the highest quality and best service available.

In 1997, Georgia Hardwoods took a giant leap into manufacturing by producing high quality raised panel doors, drawer fronts and MDF thermofoil wrapped doors. Increased demand prompted us to include the manufacturing of hardwood mouldings to complement our line of plywood and doors. In 2001, custom made dovetail drawerboxes were also added to our product line to give our customers a more complete ordering experience.



Since then, Georgia Hardwoods has invested millions of dollars in state of the art machinery and facility upgrades which enables us to be more efficient while providing the highest quality products and services. Our product line has grown to include cabinetry accents such as arch mouldings and a complete line of cabinet storage solutions.



A fully operational spray line system was installed in late 2006 and allows us to apply stain or paint finishes to most of the products we sell.

In October of 2007, we began constructing high end kitchen range hoods, which we have started accepting orders for, available in solid wood or stainless steel.



Georgia Hardwoods has a fleet of trucks from small city vans to full sized tractor trailers as well as a daily common carrier service that enables us to service the entire southeast region and beyond. Our fully stocked showroom is open six days a week and is open to the public.

Located in Buford, Georgia, Georgia Hardwoods is just minutes from the Mall of Georgia. Easily accessible from I-985, just exit at Friendship Road (exit 8 on 985), turn west toward Lake Lanier, go 1 mile to US 23 (Buford Highway), turn left, and travel 1 mile and turn left into Common Wealth Park. Georgia Hardwoods is the first warehouse on the right. Our retail store is located down the first driveway, the last door on the left.

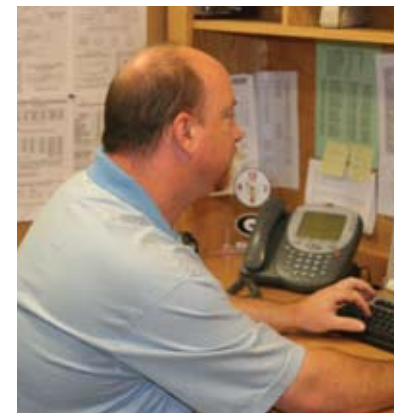

From I-85, exit at US 20 Mall of Georgia exit 115), turn west, past Mall of Georgia and go 4.5 miles to US 23 (Buford Highway), turn right, go 3.5 miles and turn right into Common Wealth Park. Georgia Hardwoods is the first warehouse on the right. Our retail store is located down the first driveway on the right, the last door on the left.

Wood Doors

Stick and Cope Doors	2-5
Applied Moulding Doors	5-6
Mitered Doors	7-8
Mitered Rail Profiles	9
Door Panel & Rail Profiles	10
Door Edge Profiles	11
Door Finishes	12-13

MDF/RTF Doors

Thermofoil Vinyl Doors	14-17
MDF/RTF Panel & Edge Profiles	18

Drawerboxes/Inserts

Dovetail Drawerboxes	20
Drawer Inserts/Pot Rack	75

Mouldings

Arch Mouldings	21
Crown	22-23
Shoe/Mull	24
Casing / Chair rail	25
Panel Mould / Bar Rail	26
Carved/Embossed	27-29

Corbels & Overlays

Vineyard Collection	30
Floral Collection	31
Acanthus Collection	32
Classic/Traditional	33
Rosettes/Shell Collection	34
Ornate Column Components	35
Valance and Specialty	36
Appliques	37
Pedestal/Bunn Feet	38
Posts	39

Range Hoods

Tuscan/Valance Series	40
Chef Series	41
Mantel/Niche Series	42
Classic Series/Hood Carvings	43
Blowers/Liners	44

Plywoods & Lumber

Industrial Plywood	45
Hardwood Lumber	46
Hardwood Plywood	47
Veneers	48-49
Melamine	50
Edgebanding	51

Cabinet Building Supplies

FastCap® Products	52-54
Glue/Bumpers	55
Sanding/Wood Filler Products	56
Softwax/3rd Hand	57
Screws	67

Slides & Pocket Doors

Pocket Door Hardware	58
Flipper Door Hardware	59
Accuride Slides	59-61
TV/Keyboard Components	62
Eclipse Slide	63
Quadro Slide System	66
White Epoxy Slide	66

Hinges/Pulls

95°-165° Hinges	67
1Piece Hinge/Plates	68
OVL/Inset Hinges	69
Knobs/Pulls	70-71

Kitchen Storage

Cabinet/Wastebasket Pullouts	72
Lazy Susans/Twin Corner	73
Appliance Garages/Tambours	74
Wine Lattice	74
Plate/Stemware racks	74
Drawer Inserts/Pot Rack	75

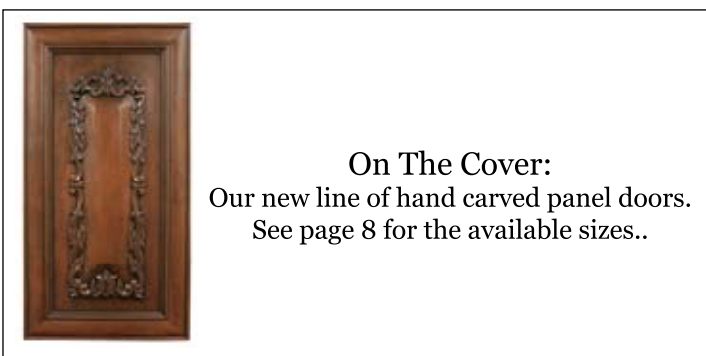

On The Cover:
Our new line of hand carved panel doors.
See page 8 for the available sizes..

Williamsburg (SRP)



SRP Drawer Front



SRP in Maple
Clear Coat, PP-1 Panel
GH-1 Edge, S-1 Rail

Concord (RRP)



RRP Drawer Front



RRP in Red Oak
Sanibel Maple Stain #55040
PP-1 Panel
GH-13 Edge, S-1 Rail

Richmond (RDP)



SDP Drawer Front



RDP in Red Oak
Clear Coat, PP-13 Panel
GH-8 Edge, S-1 Rail

Lexington (SDP)



SDP Drawer Front



SDP in Maple
Clear Coat, PP-13 Panel
GH-13 Edge, S-1 Rail

Double
Concord (2RRP)



SRP Drawer Front



2RRP in Red Oak
English Oak Stain #55010
Distressed Finish
PP-1 Panel
GH-4 Edge, S-1 Rail

Double
Richmond (2RDP)



SDP Drawer Front



2RDP in Red Oak
Solar Oak Stain #55050
PP-13 Panel
GH-8 Edge, S-1 Rail

Yorktown (ARP)



SRP Drawer Front



ARP in Mahogany
Clear Coat, PP-1 Panel
GH-17 Edge, S-1 Rail

Baltimore (ADP)



SDS Drawer Front



ADP in Maple
Spice Stain #11230
PP-13 Panel
GH-8 Edge, S-1 Rail

Jamestown (CRP)



SRP Drawer Front



CRP in Cherry
Early American Stain #22070
PP-3 Panel
GH-13 Edge, S-1 Rail

Double
Yorktown (2ARP)



SRP Drawer Front



2ARP in Mahogany
Edisto Stain #22080
PP-1 Panel
GH-17 Edge, S-1 Rail

Double
Baltimore (2ADP)



Slab Drawer Front



2ADP in Maple
Clear Coat, PP-13 Panel
GH-8 Edge, S-1 Rail

Double
Jamestown (2CRP)



SRP Drawer Front



2CRP in Cherry
Clear Coat, PP-3 Panel
GH-6 Edge, S-1 Rail

Plymouth (CDP)



SDP Drawer Front



2CDP in Cherry
Clear Coat, PP-13 Panel
GH-12 Edge, S-1 Rail

Monticello (FRP)



SRP Drawer Front



2FRP in Pine
Clear Coat, PP-3 Panel
GH-13 Edge, S-3 Rail

Hampton (SDS)



SDS Drawer Front



SDS in Maple
Tuscany Green Stain #11220
PP-12 Panel
GH-7 Edge, S-1 Rail

Double
Plymouth (2CDP)



SDP Drawer Front



2CDP in Cherry
Edisto Stain #22080
PP-13 Panel
GH-13 Edge, S-1 Rail

Double
Monticello (2FRP)



SRP Drawer Front



2FRP in Soft Maple
Cranberry Stain #11100
PP-3 Panel
GH-5 Edge, S-3 Rail

Mission (MSPP)



SPP Drawer Front



MSPP in Cherry
Early American Stain #22070
PP-13 Panel
GH-16 Edge, S-2 Rail

Shaker (SPP)



SPP Drawer Front



SPP in Cherry
Clear Coat, PP-13 Panel
GH-16 Edge, S-2 Rail

Napoli



SRPA Drawer Front



SRPA in Red Oak
Clear Coat, PP-11 Panel
GH-17 Edge
S-1 Rail Option 3 Moulding
*Specify Rail Style & Width

Perlino



MRP20 Drawer Front



MRP19 in Natural Maple
Antique White #44013
Van Dyke Glaze
PP-10 Panel
S-3 Rail Option 1 Moulding

Tuscan



MRP53 Drawer Front



MRP52 in Maple
Nutmeg Stain #11093
Van Dyke Glaze
Optional Duckmould
PP-17 Panel

Tuscan



MRP53 Drawer Front



MRP52 in Maple
Autumn Mocha #22200
Option 4 Egg & Dart Moulding
PP-17 Panel

Tuscan



MRP53 Drawer Front



MRP52 in Maple
Autumn Mocha #22200
Option 5 Braided
Rope Moulding
PP-17 Panel



Picture courtesy of Dream Cabinets

Genoa



MRP22 Drawer Front



MRP21 in Maple
Edisto Stain #22080
PP-10 Panel, GH-17 Edge
S-3 Rail Option 1 Moulding

Siena



MRP12 Drawer Front



MRP11 in Cherry
Regal Stain #22133
Van Dyke Glaze
PP-3 Panel, GH-17 Edge

Florence



MRP14 Drawer Front



MRP13 in Oak
Solar Oak Stain #55052
Black Glaze
PP-10 Panel

Milano



MRP18 Drawer Front



MRP17 in Maple
Nutmeg Stain #11093
Van Dyke Glaze
PP-10 Panel

Manchester



MRP8 Drawer Front



MRP7 in Ash
Clear Coat, PP-1 Panel,
GH-13 Edge, S-1 Rail

Windsor



MRP2 Drawer Front



MRP1 in Maple
Nutmeg Stain #11093
PP-1 Panel Van Dyke Glaze

Cambridge



MRP4 Drawer Front



MRP3 in Maple
Coffee Stain #11043F
PP-1 Panel Van Dyke Glaze

Worthington



MRP6 Drawer Front



MRP5 in Cherry
Clear Coat
PP-10 Panel

Glouster



MRP10 Drawer Front



MRP9 in Cherry
Clear Coat
PP-9 Panel

Westbury



MRP28 Drawer Front



MRP27 in Hard Maple
Nutmeg Stain #11093F
Van Dyke Glaze
PP-16 Panel

Berkshire



MRP32 Drawer Front



MRP31 in Maple
Lauren Mahogany Stain
White Glaze #26030F
PP-16 Panel

Nottingham



MRP33 Drawer Front



MRP26 in Cherry
Lighthouse Stain #22100
PP-11 Panel

Acanthus



MRP-1 in Maple
Autumn Mocha Stain #22200
Elegant Acanthus Panel

Acanthus hand carved panels are available in Cherry and Hard Maple. Each panel has an extra wide tongue to allow for trimming to a final size door. Listed below are the size panels available.

12 X 27"
12 X 33"
12 X 39"

15 X 27"
15 X 33"
15 X 39"

18 X 27"
18 X 33"
18 X 39"

21 X 27"
21 X 33"
21 X 39"



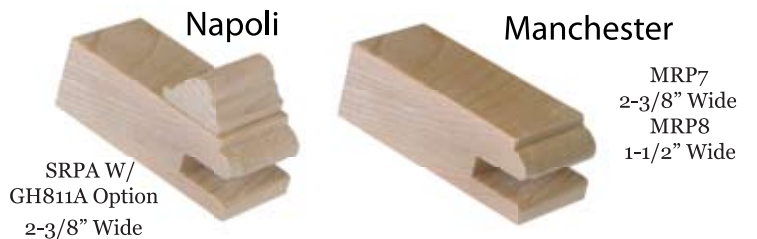
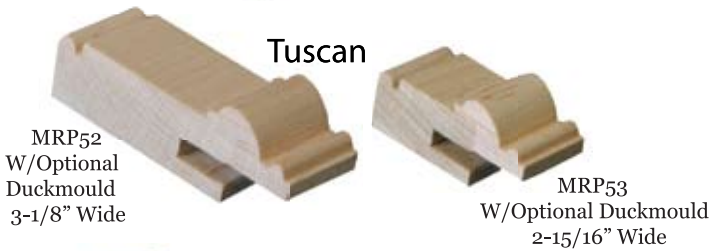
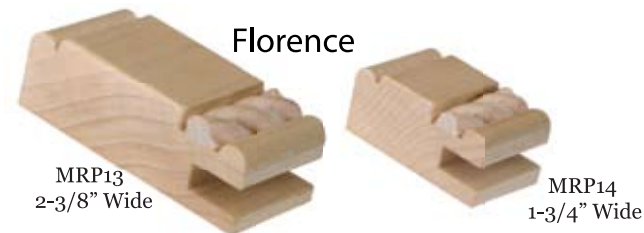
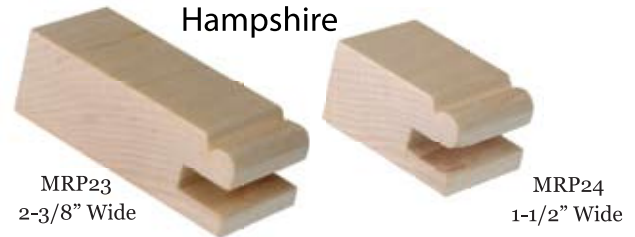
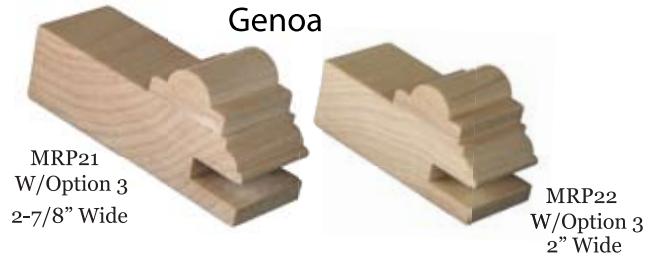
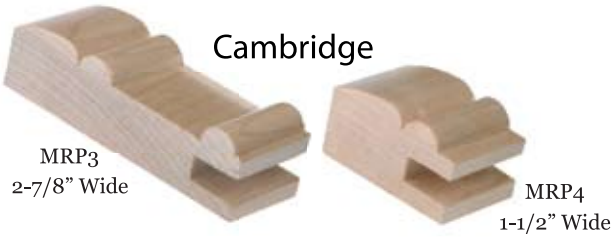

Rail & Raised Panel Profiles



PP1



PP9



PP16 *

PP13 - 1/4" Plywood Panel
Not Pictured



PP2



PP10



S-1



PP3



PP11



S-2



PP5



PP12



S-3

PP14 - 1/4" Beaded Plywood Panel
Not Pictured

* Only Available MRP 1,3,5,17 And 28 With Matching Drawer Fronts.



GH1



GH2



GH3



GH4



GH5



GH6



GH7 †



GH8 †



GH10* †



GH12*



GH13



GH15



GH16



GH17

* Not Available On Mitered Doors
And Doors 8" Or Less

† Hinge Boring Not Available

Georgia Hardwoods has a complete finishing department that handles spray and hand applied finishes. Our multistep process begins with the application of stain or paint to the raw wood followed by a sealer. Glaze is then applied, if chosen, and finally a top coat. Glaze can be applied to any of the multitude of colors we offer by flooding or point application. We also have an automated moulding sprayer capable of finishing hundreds of feet per hour. Finishing options are available for most products we sell including veneers, plywood, carvings, rangehoods and posts. Please contact your sales representative for sample chips.



Sanibel On Red Oak 55040

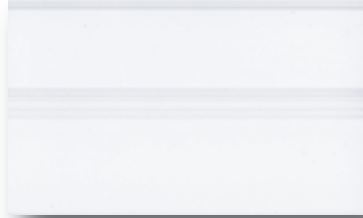

Bright White 44040



Solar Oak On Red Oak 55050



Autumn On Maple 22200



Sanibel Maple On Maple 55040

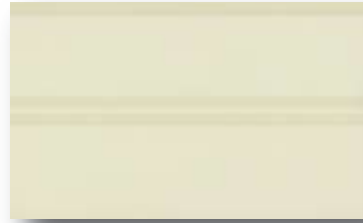

Antique White 44010



Amber On Maple 11000



Rebel Maple W/White Glaze 11174
On Maple



Rebel W/Van Dyke Glaze 11173
On Maple



Honey Maple On Maple 11130



Driftwood On Hard Maple 11110



Coffee On Soft Maple 11040



Regal On Cherry 22130



Rebel Maple On Maple 11170



Lighthouse Cherry On Cherry 22100



Nutmeg On Maple 11090



Danish On Maple 11070



Edisto On Cherry 22080



English Oak On Red Oak 55010



Tuscan Brown On Maple 11160



Coffee W/Van Dyke Glaze 11043F
On Maple



Early American On Cherry 22070



Wilmington



MSRP Drawer Front



MSRP Drawer Front



MSRP Drawer Front



MSRP Design
Frosty White
RP-21 Panel
GH-1 Edge



MSRP Design
Chocolate Pear
RP-21 Panel
GH-13 Edge



MSRP Design
Serene Cherry
RP-27 Panel
GH-20 Edge



MSRP Drawer Front



MSRP Drawer Front



MSRP Drawer Front



MSRP Design
Solar Oak
RP-22 Panel
GH-13 Edge



MSRP Design
Spiced Fruitwood
RP-22 Panel
GH-13 Edge



MSRP Design
Black Cherry
RP-22 Panel
GH-13 Edge

Portsmouth



MSRP Drawer Front



MRRP Design
Cherry Pear
RP-22 Panel
GH-3 Edge

Providence



MSRP Drawer Front



MARP Design
Select Cherry
RP-24 Panel
GH-4 Edge

Hartford



MSRP Drawer Front



MCRP Design
Hardrock Maple
RP-27 Panel
GH-20 Edge

Double
Portsmouth



MSRP Drawer Front



2MRRP Design
Hardrock Maple
RP-26 Panel
GH-6 Edge

Double
Providence



MSRP Drawer Front



2MARP Design
Mahogany Impressions
RP-23 Panel
GH-13 Edge

Double
Hartford



MSRP Drawer Front



2MCRP Design
Sanibel Maple
RP-25 Panel
GH-5 Edge

Bedford



Slab Drawer Front



Flat Arch Design
Summer Flame
RP-21 Panel
GH-13 Edge

Newport



MSDP Drawer Front



MSDP Design
Wild Apple
DP-41 Panel
GH-16 Edge

Nantucket



MSDP Drawer Front



MSDP Design
Cherry Pear
DP-41B Panel
GH-16 Edge





Design - Sunburst
 Panel - RP-21
 Edge - GH-16
 Color - Frosty White

Options:
 Square and Arch Top
 4, 7, 8, 10, 11, 13, 14 and 17 Lite



Design - French Door Lite
 Panel - RP-21
 Edge - GH-16
 Color - Frosty White

Options:
 Square and Arch Top
 4, 5, 6, 7, 9, and 11 Lite



Design - Arch Valance
 Edge - GH-16
 Color - Frosty White



Design - Scalloped Valance
 Edge - GH-16
 Color - Frosty White



Design - Raised Panel Valance
 Panel - RP-22
 Edge - GH-16
 Color - Frosty White



Flutes
 Up to 96" long
 12" wide
 -Flute count can vary
 -Flute spacing can vary
 -Straight end
 -Staggered end
 -Run off end

MDF/RTF Panel & Edge Profiles



GH1



GH5



GH12



RP21



GH2



GH6



GH13



RP22



GH3



GH7*



GH14



RP23



GH4

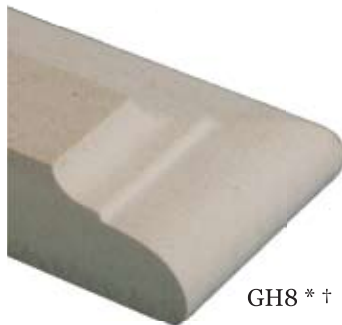

GH8*†



GH16



RP24



RP25



GH9



GH20



RP26



RP27



RP42

* CANNOT BE BORED FOR HINGES

† CANNOT WRAP WITH VINYL

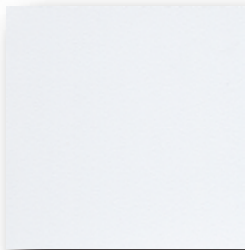

Designer White

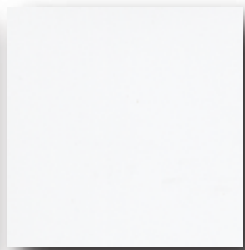

Smooth White

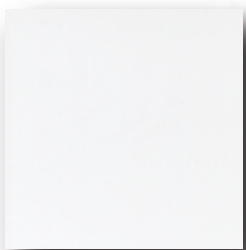

Porcelain White

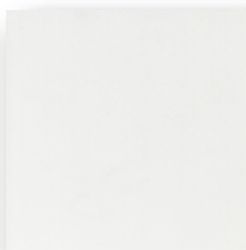

Frosty White
Matches Oxford White
Panolam®

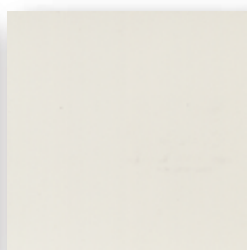

California Antique

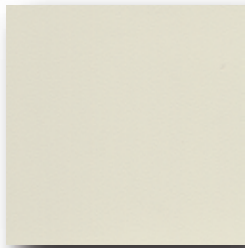

Almond
Matches Almond
Panolam®

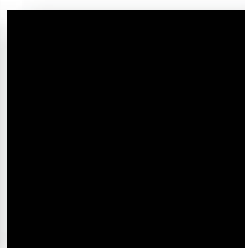

Black
Matches Black
Panolam®

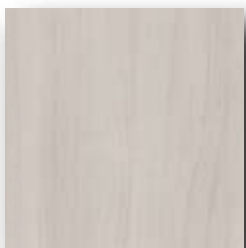

Sanibel Maple

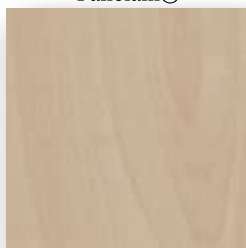

Hardrock Maple
Matches Hardrock Maple
Panolam®

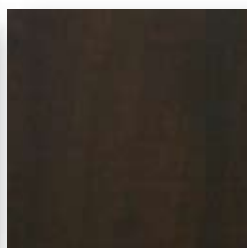

Chocolate Pear
Matches G663
GP Chocolate Apple



Wild Apple
Matches Sunrise
Panolam®

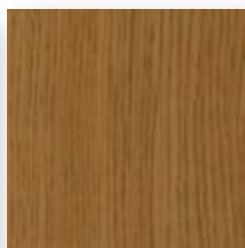

Solar Oak



Pearl Cherry
Matches Glen Cherry
Panolam®

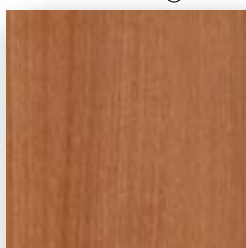

Cherry Pear

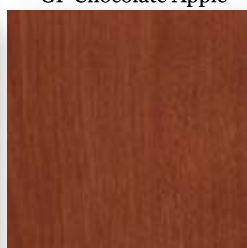

Brandy Fruitwood
Matches G667



Mocha Cherry



Summer Flame
Matches Sunset
Panolam®

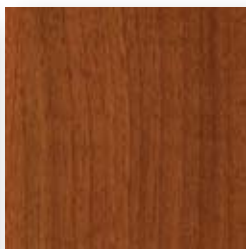

Noce D'Autore

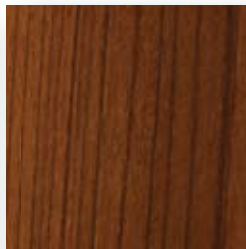

Cherry Blossom



Mahogany Impressions
Matches Mahogany
Impressions Panolam®



Spiced Fruitwood
Matches Arbor Myrtle
Panolam® & G668

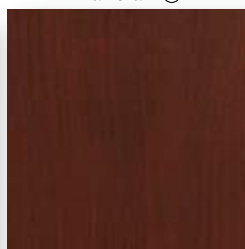

Serene Cherry
Matches G510



Jubilee Cherry



Diamond Plate



Brushed Aluminum

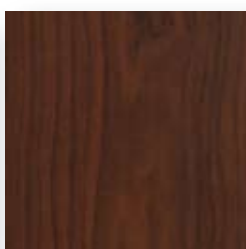

Black Cherry
Matches G511



Dovetail Drawer Boxes



Maple

Red Oak

Cherry



- Available in any specie
- 1/2" thick solid wood sides
- 1/4" matching plywood bottom
- Plywood bottom groove 1/2" from bottom
- Can be assembled or flat packaged
- Finished or unfinished
- Optional hand scoop

Undermount Drawerslide Notching

For a small charge, each drawerbox can be notched to accept undermount tandem slides including the Accuride Eclipse® Series, the Hettich® Silent System and Blum®.

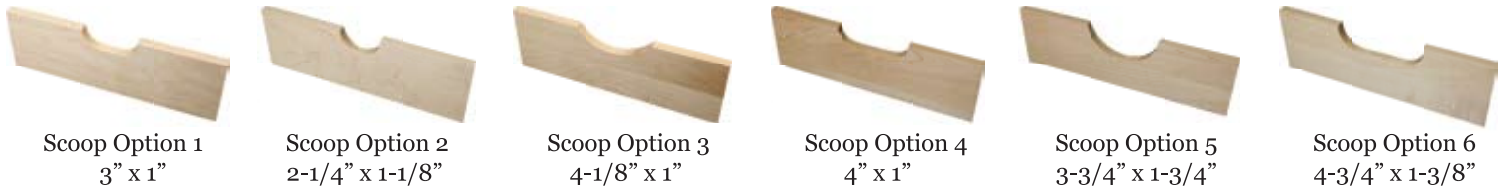

Scoop Option 1
3" x 1"

Scoop Option 2
2-1/4" x 1-1/8"

Scoop Option 3
4-1/8" x 1"

Scoop Option 4
4" x 1"

Scoop Option 5
3-3/4" x 1-3/4"

Scoop Option 6
4-3/4" x 1-3/8"

Prefinished Plywood Drawerside Stock

- 35002 1/2 X 4" X 8' 10/Box
- 35003 1/2 X 6" X 8' 10/Box
- 35004 1/2 X 8" X 8' 10/Box
- 35004 1/2 X 10" X 8' 10/Box
- 35004 1/2 X 12" X 8' 10/Box

Prefinished Birch. Sold per box
1/4" bottom groove, edgebanded top



Baltic Birch Drawerside Stock

- 35103 1/2 X 3" X 60"
- 35104 1/2 X 4" X 60"
- 35105 1/2 X 5" X 60"
- 35106 1/2 X 6" X 60"
- 35107 1/2 X 7" X 60"
- 35108 1/2 X 8" X 60"
- 35109 1/2 X 9" X 60"
- 35110 1/2 X 10" X 60"

1/4" bottom groove eased round over top



Solid Maple Drawerside Stock

- 35023 1/2 X 3"
- 35024 1/2 X 4"
- 35025 1/2 X 5"
- 35026 1/2 X 6"
- 35027 1/2 X 7"
- 35028 1/2 X 8"
- 35029 1/2 X 10"

1/4" bottom groove





With the increased interest in arched architectural designs of today's cabinetry and trim work, Georgia Hardwoods is pleased to offer you a new line of arched mouldings.

From arched doors and windows to valances, we offer dozens of moulding profiles to fit your custom design applications. Arched mouldings are available in all of our moulding profiles used in flat applications, excluding the bar rail profiles. The same knives from our straight moulding manufacturing process are used in the arch mouldings ensuring a perfect match in every kit.

Arched moulding kits include several arched moulding pieces and 2 straight moulding pieces (approximately 8 ft in length) of the same profile. Kit pricing is based on the wood specie and profile. For most profiles, arched moulding kits can be produced in approximately two weeks. Additional options are available to enhance the arch moulding kit which include keystones, plynth blocks, rosettes and appliques.

Each arch will be machined in as few segments as possible. Each segment is cut and secured to a master template of the size given for the job. The master template containing the segments are machined at the same time to guarantee perfect alignment.

When ordering, please specify the arch type and its inside measurement. For the eye brow arch, a rise measurement will have to be supplied. For all elliptical arches a template must be supplied for accuracy. Please account for the reveal of the window or doorway casing. The arch moulding will be machined to the exact size given. Please see the arch moulding order form for more details at www.gahwd.com/downloads.

Three Types of Arch Mouldings:

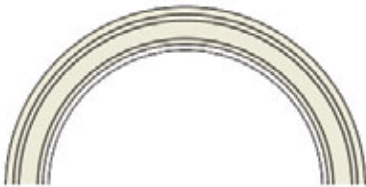

TRUE HALF-CIRCLE ARCH

Please include the inside radius measurement plus reveal when ordering.



EYE BROW ARCH

Please include the dimensions for width and center rise measurements plus reveal when ordering.



ELLIPTICAL ARCH

Please provide a template on paper or cardboard when ordering.



Crown Moulding



GH68
2" Crown
3/8 X 1-3/4"
Rise 1-1/4"
Projection 1-1/4"



GH403
2-1/2" Crown
11/16 X 2-3/4"
Rise 2-1/4"
Projection 2-5/8"



GH52
3" Crown
3/4 X 2-5/8"
Rise 2"
Projection 1-3/4"



GH52A
3" Crown
3/4 X 2-3/4"
Rise 2"
Projection 2"



GH404
3" Crown
11/16 X 3-1/4"
Rise 2-5/8"
Projection 2"



GH50
4" Top Mount Crown
7/8 X 3-3/8"
Rise 2"
Projection 2-7/8"



GH401
4" Crown
3/4 X 3-1/2"
Rise 2-7/8"
Projection 2-1/16"



GH49
4" Crown
3/4 X 3-5/8"
Rise 3"
Projection 2"



GH405
4-1/2" Crown
5/8 X 4-7/16"
Rise 3-3/16"
Projection 3-3/16"



GH4
4" Dentil Crown
13/16 X 3-11/16"
Rise 2-1/2"
Projection 2-3/4"
Accepts 3/4" Inserts



GH51
4" Top Mount
Dentil Crown
13/16 X 4-1/8"
Rise 3-1/8"
Projection 3-1/8"
Accepts 3/4" Inserts



GH47
5" Crown
3/4 X 4-5/8"
Rise 3-5/8"
Projection 2-3/4"



GH601
6" Crown
3/4 X 5-5/8"
Rise 4-7/16"
Projection 3-3/8"



GH7
6" Dentil Crown
3/4 X 5-1/2"
Rise 4-3/8"
Projection 3-9/16"
Accepts 3/4" Inserts



GH9
6" Top Mount
Dentil Crown
1-1/8 X 5-7/8"
Rise 4"
Projection 4-3/4"



GH17
6" Crown
3/4 X 5-1/2"
Rise 4-5/8"
Projection 3"



GH525
6" Beaded Crown
13/16 X 5-1/2"
Rise 4-3/8"
Projection 3-3/8"



Specify Specie When Ordering

Shoe/Mull/Corner/Scribe



GH6
Shelf Cap/
Panel Mould
9/16 X 1-3/16"



GH15
Corner
3/4 X 3/4"



GH7001
Mull
5/8 X 1-1/4"



GH127
Shoe
7/16 X 11/16"



GH163
Base Cap
3/4 X 1-1/2"



GH204
Corner
1/2 X 1/2"
1/4" Thick



GH811A
Mull
7/16 X 3/4"



GH369
Mull
5/16 X 3/4"



GH40
Shelf Cap
7/16 X 15/16"



GH205
Corner
3/4 X 3/4"
1/4" Thick



GH173
Mull
5/16 X 3/4"



GH142
Mull
5/16 X 3/4"



GH41
Shelf Cap
11/16 X 1-1/4"



GH206
Corner
13/16 X 13/16"
1/4" Thick



GH174
Mull
1/2 X 3/4"



GH987
Mull
3/8 X 1-3/8"



GH800
Base Cap
3/4 X 1-3/16"



GH820
Scribe
5/16 X 7/8"



GH811
Mull
3/4 X 1-1/2"



GH119
Half Round
3/4 X 1-1/2"



GH938
Scribe
5/16 X 1-1/8"



GH22-1/2
Mull
3/4 X 1-1/2"



GH105
Quarter
3/4 X 3/4"



GH422
Beaded T&G
1/2 X 3-3/8"



GH422A
T&G
1/2 X 3-3/8"

GH445
T&G
3/4 X 5-1/2"



GH5
Cap
3/4 X 1-1/8"



GH108
Quarter
1/2 X 1/2"



Qtr 5/16" Rope
8' Lengths



GH1010
Chair Rail
3/4 X 2-1/2"



GH623
Base
7/16 X 3-1/4"



GH66B
Casing
3/4 X 6"



GH356
Casing
3/4 X 2-1/4"



3/8" Rope
8' Lengths



GH1000
Chair Rail
3/4 X 2-1/4"



GH2
Base
3/4 X 2-1/2"



GH66
Casing
3/4 X 3-1/2"



GH234
Casing
3/4 X 2-3/4"



3/4" Rope
8' Lengths



GH350
Chair Rail/
Door Casing
3/4 X 3-1/2"



GH8000
Chair Rail
3/4 X 2-3/4"



GH66A
Casing
1/2 X 2"



GH3
Casing
1 X 3-1/2"



1-1/4" Rope
8' Lengths



GH824
Chair Rail
3/4 X 2-3/4"



GH440
Chair Rail
1-1/2 X 3"



GH7023A
Casing
3/4 X 3-1/2"



GH3A
Casing
3/4 X 2-1/2"



3/4 X 3/4"
Dentil Insert



GH425
Casing
3/4 X 4-1/8"



GH20
Chair Rail
1-1/2 X 5-1/2"



GH804
Chair Rail
3/4 X 4-3/4"



GH617
Base
3/4 X 5-1/4"

Specify Specie When Ordering

Panel Mould/Bar Rail/ Rosettes



GH8
Shelf Cap
11/16 X 1"



GH8a
Panel Mould
11/16 X 1"
1/2" Rabbet



GH42-3/4
Panel Mould
1 X 1-5/8"
3/4" Rabbet



GH840
Panel Mould
1 X 3-1/2"
3/4" Rabbet



GH807
Panel Mould
1 X 2-3/4"
3/4" Rabbet



GH116A
Panel Mould
3/4 X 1-1/4"
3/8" Rabbet



GH116B
Panel Mould
9/16 X 3/4"
3/8" Rabbet

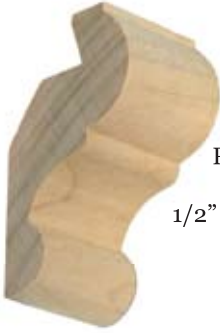

GH43
Panel Mould
3/4 X 2"
1/2" - 3/4" Adj. Rabbet



GH42
Shelf Cap/
Panel Mould
1 X 1-5/8"



GH30D Keystone
6-3/4" Top
2-7/8" Bottom
8" Tall 1" Thick



GH805A Bar Rail
6-1/8 X 1-1/2"
Uses Two 3/4" Sheets For Slope



GH30E Rosette
7/8 X 6-1/4" Sq
Matches GH66B
Flute / Bead
Casing



GH30 Rosette
7/8 X 3-3/4" Sq
Matches GH66
Flute / Bead
Casing



GH30A Rosette
3/4 X 2-1/4" Sq
Matches GH66A
Flute / Bead
Casing



GH805 Bar Rail
6-1/8 X 1-1/2"
2-3/4" Tall X 4" Wide For Slope
Approx 35° Angle



GH30F Plynth
1 X 6-1/2 X 8" Sq
Matches GH66B
Flute / Bead Casing



GH30B Plynth
1 X 4 X 6" Sq
Matches GH66
Flute / Bead Casing



GH30C Plynth
3/4 X 2-1/2 X 4-1/2" Sq
Matches GH66A
Flute / Bead
Casing



CM8808 Ornat Crown
7-1/2" x 7/8" Repeats 7-1/2"



CM8810 Ornat Crown
4-3/4" x 15/16" Repeats 4-3/4"



CM8812 Ornat Crown
6" X 1"



CM8820 Ornat Crown
2-3/4" x 13/16" Repeats 2-7/8"



CM8854 Ornat Crown
7-1/2" x 1-1/16"



CM8856 Ornat Crown
6-1/2" x 13/16"



FR8958 Ornat Frieze
5-1/2" x 13/16"



FR8954 Ornat Frieze
5-1/2" x 13/16"



FR8953 Ornat Frieze
5-1/2" x 13/16"



FR8921 Ornat Frieze
3-3/4" x 13/16"



MLD5848 Large Egg and Dart
4-3/4" x 13/16" Repeats 1-3/4"



MLD5840 Large Acanthus Crown
4-3/4" x 13/16" Repeats 3-1/2"



CR864 Crown 5" X 3/4"
Shown in Coffee Stain with Brown Glaze



CR881 Crown 4-1/8" X 13/16"
Shown in Coffee Stain with Brown Glaze



MLD5916 Vineyard Frieze
3-1/2" X 13/16" Repeats 17-3/4"



MLD5914 Acanthus Scrolls
3-1/2" X 13/16" Repeats 10"



MLD5940 Acanthus Panel Mould
1-1/2" X 5/8" Repeats 1-5/8"



MLD5903 Running Palmette
5-1/4" X 13/16" Repeats 9-3/4"

MLD5922 Running Palmette
3-1/2" X 13/16" Repeats 6"



MLD5810 Lg. Reeded Half Lineal
2" X 1" x 96"



MLD5812 Med. Reeded Half Lineal
1-1/2" X 3/4" x 96"



MLD5814 Sm. Reeded Half Lineal
1" X 1/2" X 96"



MLD5830T Lg. Traditional Pilaster
4-1/4" X 3/4"



MLD5980 Lamb's Tongue
1-1/4" x 11/16" Repeats 1-1/2"



MLD5970 Lamb's Tongue
1-1/2" x 3/4"



MLD5979 Egg and Dart
1 X 3/4" Repeats 1-5/8"



MLD5976 Egg and Dart
3/4" x 5/8" Repeats 1-7/8"



MLD6000 Egg and Dart Insert
1/2" x 3/8"



CA8320 Running Leaf & Beads
4-1/2" X 1-1/4"



FR8965 Rinceau Scrolls
5-1/2" x 13/16"



FR8956 Grapevine & Tassels
5-1/2" x 13/16"



FR8971 Acanthus Leaf & Tongue
6-3/4" x 13/16"



PM8552 Reed & Ribbon
2" x 13/16"



PM8569 Reed & Ribbon with Beads
2-1/2" x 13/16"



PM8511 Running Leaf
2" x 13/16"



PM8545 Small Rope
9/16" X 1" Repeats 3/4"
PM8546 Large Rope
7/8" X 1-3/4" Repeats 1-1/4"



PM8540 Small Rope
1" x 5/8"



PM8535 Small Egg & Dart
1-1/2" x 3/4"



PM8524 Small Beads
5/8" x 1" Repeats 1/4"
PM8525 Large Beads
7/8" X 1-1/2" Repeats 1/2"



PM71 Panel Mould
1-3/4" X 3/4"
Shown in Antique White
with Brown Glaze



PM59 Panel Mould
3/4" X 5/8"
Shown in Antique White
with Brown Glaze



PM12 Panel Mould
5/8" X 1-1/8"
Shown in Antique White
with Brown Glaze



PM14 Panel Mould
1/2" X 1"
Shown in Antique White
with Brown Glaze



Wood Knob
 CRV5036 -L 1-5/16 X 1-1/2" Dia.
 4 Per Card



Drawer Pull Pair
 CRV5034 -L 1-1/4 X 1-7/8 X 4-1/2"



Drawer Pull
 CRV5032 -L,C,M 1-1/2 X 3-3/4 X 12"



Grape Cluster Overlay
 CRV5028 -L
 3/4 X 5 X 6-1/4"
 L and R pair per card



Vineyard Medallion
 CRV5038 -L,C,M
 1 X 6 X 14-1/4"



Flower Center Vineyard Cluster
 CRV5030 -L 13/16 X 3-1/2 X 15-3/4"

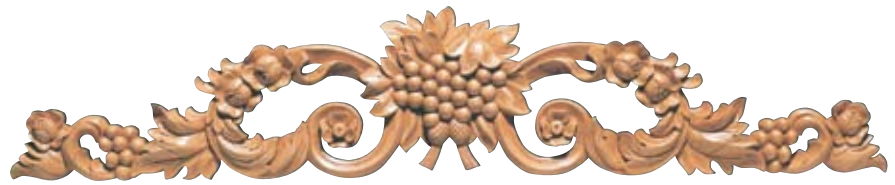

Vineyard Scroll Overlay
 CRV5020 -L,M 7/8 X 7 X 36"
 CRV5022 -L,C,M 3/4 X 4-1/2 X 24"

Vineyard Corbels



CRV5110 -L,C,M
 5-1/2 X 7 X 15"
 CRV5112 -L,C,M
 4-3/4 X 5-1/4 X 10"



CRV5100 -L,C,M
 3-1/2 X 8 X 13"



Vineyard Acanthus Overlay
 K-Y2124 -C,M 5-1/2 X 24 X 3/4"
 K-Y2136 -C,M 7-1/2 X 36 X 1"



Vineyard Scrolls
 CRV5024 -L,C,M 13/16 X 4 X 9"
 CRV5026 -L 5/8 X 2-1/2 X 6"
 L and R pair per card

L = Lindenwood, C = Cherry, M = Maple



Floral Corbel

CRV5216 -L 7-1/2 X 11-1/2 X 24"
 CRV5218 -L 6 X 8-1/4 X 14-1/2"
 CRV5220 -L 4 X 9-1/4 X 14-1/2"



Large Floral Drop

CRV5087 -L
 1 X 5-1/2 X 14"



Small Floral Drop

CRV5089 -L
 1 X 5-1/2 X 8"



Ribbon Drop

CRV5636 -C,M
 2-1/4 X 9 X 1/2"
 2 per card



Large Floral Scrolls

CRV5067 -L
 13/16 X 5-1/2 X 11"
 L and R per card



Medium Floral Scrolls

CRV5068 -L,C,M
 3/4 X 3-1/2 X 7"
 L and R per card



Petite Drop

CRV5638 -C,M
 1-7/8 X 7-1/2 X 1/2"
 2 per card



Laurel Swag

CRV5072 -L 3/4 X 5 X 12"



Floral Scroll Center

CRV5050 -L 3/4 X 5-1/2 X 24"
 CRV5051 -L 5/8 X 3-1/4 X 12"



Floral Swag

CRV5069 -L 1-1/2 X 6 X 16"
 CRV5070 -L 1-1/2 X 4-1/2 X 12"



Laurel Center

CRV5053 -L
 3/8 X 8-1/4 X 8"

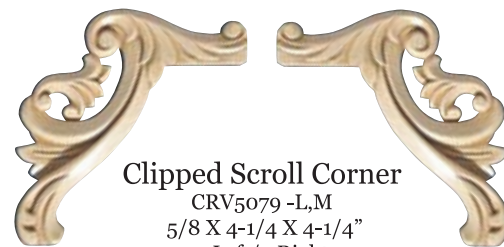

Clipped Scroll Corner

CRV5079 -L,M
 5/8 X 4-1/4 X 4-1/4"
 2 Left/2 Right



Rose Swag

CRV5071 -L
 1-3/16 X 6-5/16 X 12"



Flower Basket

CRV5058 -L
 1 X 10-1/2 X 10"

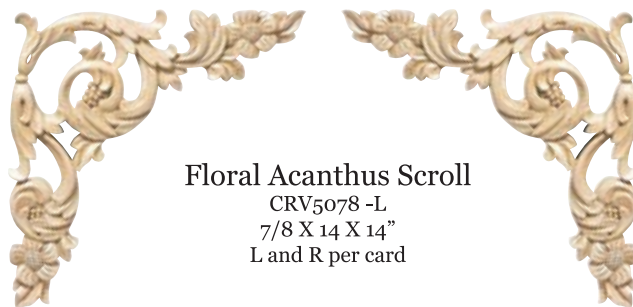

Floral Acanthus Scroll

CRV5078 -L
 7/8 X 14 X 14"
 L and R per card

L = Lindenwood, C = Cherry, M = Maple



Acanthus Corbel
 CRV5097 -L,C,M 7-7/8 X 6 X 14-1/2"
 CRV5098 -L,C,M 5 X 4-1/2 X 12"



Acanthus Fluted Corbel
 CRV5205 -L 9 X 10 X 36-1/2"
 CRV5210 -L 7-1/2 X 8-1/2 X 24"



Acanthus Leaf Corbel
 CW-SYCA205-B 12 X 13/16 X 7/16"



Acanthus Spool Corbel
 CRV5568 -C,M 3-3/8 X 5-1/2 X 1-1/8"
 CRV5570 -C,M 3-3/8 X 3-3/4 X 3/4"
 CRV5572 -C,M 2-5/8 X 5-1/2 X 1-1/8"
 CRV5574 -C,M 2-5/8 X 3-3/4 X 3/4"
 2 per card



Acanthus Capital
 CRV5130 -L,C,M 1-3/4 X 8 X 8"
 CRV5133 -L,C,M 1-3/8 X 6 X 6"
 CRV5136 -L,C,M 1-1/4 X 3-1/4 X 3-1/4"



Large Acanthus Capital
 CRV5129 -L 2-3/4 X 14-1/4 X 12"



Petite Acanthus Corbel
 CRV5125 -L,C,M 3 X 1-3/4 X 4-1/2"
 2 per card



Medallion Block
 CRV5123 -L 1-3/4 X 1-1/2 X 2-3/4"
 4 per card



Acanthus Leaf Accent
 CRV5576 -C,M 3-1/2 X 4-1/4 X 3/4"
 CRV5578 -C,M 2-5/8 X 5-1/2 X 1-1/8"
 2 per card



Acanthus Leaf Accent
 CRV5181 -L 1/2 X 3-7/8 X 3-7/8"
 CRV5183 -L 3/8 X 2-5/8 X 2-5/8"
 4 per card



Acanthus Corner Plume
 CRV5073 -L 13/16 X 12 X 12"
 CRV5074 -L 13/16 X 8 X 8"
 CRV5075 -L,C,M 5/8 X 4 X 4"
 2 per card



Acanthus Plume
 CRV5642 -C,M Pair 3 X 5 X 5/8"
 2 per card



Acanthus Overlay
 CRV5046 -L,C,M 7/8 X 7-1/2 X 36"
 CRV5048 -L,C,M 3/4 X 6 X 24"
 CRV5049 -L,C,M 5/8 X 4 X 12"



Acanthus Continuous Scrolls
 CRV5634 -L 13/16 X 4-1/2 X 16"
 2 L and 2 R per card



Acanthus Scrolls
 CRV5065 -L 13/16 X 4-1/2 X 16"
 CRV5066 -L,C,M 13/16 X 3-1/2 X 12"
 L and R per card

Acanthus Crown Corner Block
 CRV5095 -L 5-1/2 X 5-1/2 X 12-1/8"
 Accepts most 5-1/4" to 7-1/2" crowns.

CRV5099 -L 3-1/2 X 3-1/2 X 8-1/2"
 Accepts most crowns up to 5" wide.





Classic Scroll Corbel

CRV5105 -L,C,M 5-1/4 X 4-1/2 X 12-1/2"
 CRV5106 -L 5-3/4 X 4-1/2 X 9-3/4"
 CRV5107 -L 3-3/4 X 3-1/2 X 6-1/2"



Classic Fluted Corbel

CRV5256 -L 3-1/2 X 12 X 7-1/2"



Classic Fluted Corbel

CRV5250 -M 5 X 11 X 3"



Classic Fluted Corbel

CRV5092 -L 9 X 7 X 24"
 CRV5094 -L 7 X 6 X 14"



Traditional Corbel

K-Y2222 -C,M 6 X 3 X 3"
 K-Y2223 -C,M 9 X 5-3/4 X 6-1/16"
 Accepts 3/4" W X 1/2" D
 accent mouldings.



Fluted Scroll Corbel

CRV5236 -L 9-1/4 X 16-1/2 X 6"
 CRV5238 -L 7-3/4 X 14 X 3"
 CRV5240 -L 5-1/2 X 10 X 2-1/2"



Imbricated Corbel

CRV5236 -L 9-1/4 X 6 X 16-1/2"
 CRV5238 -L 7-3/4 X 3 X 14"
 CRV5240 -L,M 5-1/2 X 2-1/2 X 10"



Traditional Bar Bracket

2-7/8 X 10-3/4 X 6-3/8"
 CW-SYCABB2-M Maple
 CW-SYCABB2-C Cherry
 * CW-SYCA206B Birch



Petite Classic Corbel

CRV5126 -L,C,M
 3 X 1-3/4 X 4-1/2"



Classic Capital

CRV5139 -L 2-3/4 X 13 X 9"



Corinthian Capital

CRV5140 -L 1-11/16 X 3-1/2 X 8"
 CRV5143 -L 1-1/8 X 3 X 7"
 CRV5146 -L 1-3/16 X 2 X 3-1/2"



Classic Plynth Block

CRV5147 -L 3-1/2 X 5-1/2 X 11-1/2"
 CRV5148 -L 2-1/2 X 3-1/2 X 7-1/4"
 CRV5149 -L,C,M 1-7/8 X 3 X 6-1/4"
 CRV5150 -L,C,M 1-3/8 X 1-1/2" X 2-7/8"



Scrolled Corbel

CRV5604 -C,M 3 X 5-1/2 X 1-3/4"
 CRV5606 -C,M 2 X 3-3/4 X 1-1/4"
 CRV5608 -C,M 1-1/2 X 2-3/4 X 7/8"



Traditional Overlay

K-Y2220 -C,M 5 X 20 X 3/4"
 K-Y2230 -C,M 5 X 30 X 1"



Traditional Capital

CRV5580 -M 5-1/2 X 1-3/4"
 Accepts CRV5164, CRV5586
 CRV5614, CRV5620, CRV5576
 CRV5584, CRV5469 Rosettes
 Fluted moulding up to 4-1/4"W
 by 3/4" Thick.

CRV5582 -M 4-1/2 X 1-5/8"
 Accepts CRV5578, CRV5586
 CRV5588, CRV5187 Rosettes.
 Fluted moulding up to 3"W
 by 3/4" Thick.



Acanthus Shell Corbel
 CRV5120 -L,C,M
 6 X 2-1/2 X 14"
 CRV5121 -L,C,M
 4-1/2 X 1-3/4 X 10"



Shell and Floral Drop
 CRV5077 -L 5/8 X 4-1/2 X 10"



Shell with Scrolls Overlay
 CRV5040 -L 7/8 X 7 X 36"
 CRV5043 -L 3/4 X 5 X 24"
 CRV5044 -L 5/8 X 4 X 12"



Shell Center
 CRV5055 -L
 1 X 8 X 7-1/2"



Shell Keystone
 CRV5127 -L
 2-1/2 X 8 X 9-1/2"

Rosettes



Square Rosette
 CRV5160 -L,C,M
 5/8 X 5 X 5"
 CRV5164 -L,C,M
 3/8 X 3-1/2 X 3-1/2"
 2 per card



Rectangular Rosette
 CRV5172 -L 3/4 X 3-1/2 X 5-1/2"
 CRV5173 -L 5/8 X 2-3/4 X 4-1/2"
 2 per card



Oval Rosette
 CRV5177 -L
 7/8 X 4-1/2 X 6-1/2"
 CRV5178 -L Pair
 3/4 X 3-1/2 X 5"
 CRV5179 -L,C,M Pair
 5/8 X 2-3/4 X 4"



Round Rosette
 CRV5096 -L Pair
 3/8 X 3"
 2 per card



Acanthus Rosette
 CRV5620 -C,M
 2-3/4 X 3/4"
 4 per card



Flower Rosette
 CRV5618 -C,M
 2-3/4 X 3/4"
 4 per card



Petite Square Rosette
 CRV5090 -L
 3/8 X 1-7/8 X 1-7/8"
 4 Per Card



Petite Round Rosette
 CRV5093 -L
 3/8 X 1-7/8"



Acanthus Rosette
 CRV5590 -C,M 5-1/2 X 1-3/4"
 CRV5592 -C,M 4-1/2 X 1-5/8"
 CRV5594 -C,M 3-1/2 X 1-3/8"
 CRV5596 -C,M 2-1/2 X 7/8"



Acanthus Rosette
 CRV5166 -L 7/8 X 7"
 CRV5168 -L,C,M
 Pair 3/4 X 5"
 CRV5169 -L,C,M
 Pair 5/8 X 3-1/2"



Rope Rosette
 K-Y3074 -C,M 5 X 7/8"
 K-Y3075 -C,M 2-7/8 X 7/16"



Sq Acanthus Rosette
 K-Y2256 -C,M 5 X 7/16"
 K-Y2253 -C,M 2-7/8 X 7/16"



Classic Button
 CRV5586 -L 3-1/2 X 5/8"
 4 per card
 CRV5588 -L 1-1/4 X 3/8"
 8 per card



Fleur de lis Rosette
 CRV5185 -L
 1-1/2 X 3-1/2 X 4-1/8"
 CRV5187 -L
 3/8 X 2-1/4 X 2-3/4"
 4 per card



Star Rosette
 CRV5193 -L 5/8 X 4"
 CRV5194 -L 1/2 X 2-1/2"
 4 per card

Star Block Rosette
 CRV5197 -L 1-3/8 X 5-1/2"
 CRV5198 -L 1-3/8 X 3-1/2"
 2 per card

L = Lindenwood, C = Cherry, M = Maple



Traditional Capital
 CRV5512 -C,M Pair
 3-1/2 X 4-3/4 X 1-3/4"
 CRV5514 -C,M Pair
 2-5/8 X 3-5/8 X 1-3/8"
 CRV5516 -C,M Pair
 1-3/4 X 2-3/8 X 7/8"



Papyrus Capital
 CRV5506 -C,M Pair
 3-1/2 X 4-3/4 X 1-3/4"
 CRV5508 -C,M Pair
 2-5/8 X 3-5/8 X 1-3/8"
 CRV5510 -C,M Pair
 1-3/4 X 2-3/8 X 7/8"



Acanthus Capital
 CRV5500 -C,M Pair
 4-5/8 X 4-3/4 X 2-3/8"
 CRV5502 -C,M Pair
 3-1/2 X 3-5/8 X 1-3/4"
 CRV5504 -C,M Pair
 2-3/8 X 2-3/8 X 1-1/8"



Traditional Splicer
 CRV5524 -C,M Pair
 3 X 3-1/4 X 1-1/2"
 CRV5526 -C,M Pair
 2-1/4 X 2-3/8 X 1-1/8"
 CRV5528 -C,M Pair
 1-1/2 X 1-5/8 X 3/4"



Vinyard Concave Splicer
 K-YT1522-SCH
 K-YT1522-SHM
 1-3/4" W X 2-1/2" H X 7/8" D



Vinyard Barrel Splicer
 K-YT1520-SCH
 K-YT1520-SHM
 1-3/4" W X 2-1/2" H X 7/8" D



Acanthus Concave Splicer
 K-YT1522-ACH
 K-YT1522-AHM
 1-3/4" W X 2-1/2" H X 7/8" D



Acanthus Barrel Splicer
 K-YT1520-ACH
 K-YT1520-AHM
 1-3/4" W X 2-1/2" H X 7/8" D



Fluted Column
 K-T1573CH
 K-T1573HM
 1-1/2" W X 3/4" D X 8' L



Beaded Column
 MLD5810C 2"W X 1" D x 8' L
 MLD5810M 2"W X 1" D x 8' L
 MLD5812C 1-1/2"W X 3/4" D x 8' L
 MLD5812M 1-1/2"W X 3/4" D x 8' L
 MLD5814C 1"W X 1/2" D x 8' L
 MLD5814M 1"W X 1/2" D x 8' L



Acanthus Finial
 CRV5536 -C,M Pair
 2-3/8 X 4-1/4 X 1-1/4"
 CRV5538 -C,M Pair
 1-3/4 X 3-1/8 X 7/8"
 CRV5540 -C,M Pair
 1-1/4 X 2-1/8 X 5/8"



Traditional Finial
 CRV5542 -C,M Pair
 2-3/8 X 4-1/4 X 1-1/4"
 CRV5544 -C,M Pair
 1-3/4 X 3-1/8 X 7/8"
 CRV5546 -C,M Pair
 1-1/4 X 2-1/8 X 5/8"



Bottle Base Block
 K-T1502CH
 K-T1502HM
 2-5/8" W X 4" H X 1-1/4" D



Capped Base Block
 K-T1501CH
 K-T1501HM
 2-5/8" W X 4" H X 1-1/4" D



Traditional Plynth Block
 CRV5530 -C,M Pair
 2-3/8 X 3-3/4 X 1-7/8"
 CRV5532 -C,M Pair
 1-3/4 X 2-3/4 X 1-3/8"
 CRV5534 -C,M Pair
 1-1/8 X 1-7/8 X 1"



End Block
 CRV5518 -C,M Pair
 3-1/2 X 5-3/4 X 1-3/4"
 CRV5520 -C,M Pair
 2-5/8 X 5-3/4 X 1-3/8"
 CRV5522 -C,M Pair
 1-3/4 X 5-3/4 X 7/8"



L = Lindenwood, C = Cherry, M = Maple

Carved Valances



Traditional Scroll Valance
K-Y6620CH K-Y6620SM 6-1/2 X 61 X 1-1/4"



Sonoma Vinyard Valance
K-Y6624CH K-Y6624SM 6-1/2 X 61 X 1-1/4"



Acanthus Valance
K-Y6643CH K-Y6643SM 6-1/2 X 61 X 1-1/4"

Specialty Corbels



Horse
CW-SYCH-001
12 X 3-1/2 X 9"
CW-SYCH-002
9 X 3-1/2 X 6"



Elephant
CW-SYEL-001
13 X 4 X 9"



Eagle
CW-SYEA-001
12 X 4 X 9"



Village
CW-SYV-001
12 X 3-1/2 X 9"



Lion
CRV5091 -L
8 X 6-1/2 X 26"

Specialty Overlays



Elephant Overlay
CW-SYEL-3054 6-1/2 X 20 X 1-1/2"



Eagle Overlay
CW-SYEA-3057 6-1/2 X 20 X 1-1/2"



Lion Overlay
CRV5195 -L
1-1/2 X 6-1/2 X 7"



Horse Overlay
CW-SYCH-3040 6-1/2 X 20 X 2"



Large Urn
CRV5060 -L 3/4 X 6-1/2 X 11"



Small Urn
CRV5063 -L
3/4 X 6-1/2 X 3-1/4"



AW500 Birch 3 X 7"



AW574 Birch 4-1/4 X 14-1/4"



AW3556 Birch
3-1/2" Sq



AW3602 Birch
3-3/8 X 3-7/8"



AW633 Birch
AW633 Cherry
4" Diameter
AW3633A Birch
3-1/2" Diameter



AW538 Birch 2 X 9"
AW538 Oak



AW3209 Birch 2-1/2 X 8"



AW3547 Birch
AW3547 Cherry
AW3547 Oak
4-7/8" Sq



AW607 Birch
3-3/4 X 4-1/2"



AW3597 Birch
3" Diameter



AW604 Birch 3-3/4 X 10-1/2"



AW3218 Birch 1-3/4 X 9-1/4"



AW673 Birch 3 X 7-1/2"



AW3182 Birch 2 X 10"



AW3546 4" Sq
AW3546A 2-1/2" Sq
All Available In
Birch, Cherry
or Oak



AW567 Birch
5" SQ



AW3465 Birch
1-1/2 X 3"
AW3466 Birch
2-1/4 X 4-3/8"



AW608 Birch 2-1/2 X 6"
AW608 Oak



AW613 Birch 2-1/2 X 10-5/8"
AW613 Oak



AW9019 Birch
3-3/16 X 5-11/16"



AW3451 Birch
1-3/4 X 3-1/2"



AW7089 Birch 5-1/4 X 10-3/8"



AW892 Birch 5-1/2 X 19-1/4"



AW3151 Birch
1-1/4" Sq



AW692 Birch
3-1/2 X 9"



AW3312 Birch
2-1/2 X 4-3/4"



AW2000 Birch 3-1/4 X 10-3/4"



AW3654 Birch 4-1/4 X 20-1/2"



AW683 Birch 5 X 6-1/8"



AW578 Birch 5-1/2 X 11-1/2"



AW3587 Birch
5-3/8 X 10-1/8"



AW690 Birch
9-1/2 X 4"



AW3200 Birch
2-1/2 X 7"



AW9017 Birch 5-5/8 X 15-1/2"



AW660 Birch 4-1/4 X 8"



AW8421 Birch
2 X 9-3/4"



AW687 Birch
3-5/8 X 4-1/8"



AW3344 Birch
3-1/4 X 3-1/2"



AW9371 Birch 3-1/4 X 11-3/4"



AW3166 Birch
AW3166 Oak
1-1/2 X 5-1/2"



AW561 Birch
1-1/2 X 12"



AW3325 Birch
2-3/4 X 3-5/8"



Pedestal Foot Center
11 X 1-3/4 X 1-3/4"
CW-SYPF170-M
CW-SYPF170-C



Pedestal Foot Center
16 X 2-1/2 X 1"
FT6274M
FT6274C



French Leg Bunn Foot
2-7/16 X 4-1/2"
CW-SYBF179-M
CW-SYBF179-C



Pedestal Foot 6 X 4-1/2 X 1"
CW-SYPF171-M Left
CW-SYPF172-M Right
CW-SYPF171-C Left
CW-SYPF172-C Right



Pedestal Corner Foot
8-1/4 X 4 X 1-5/8"
FT6270M
FT6270C



Pedestal Foot
8-1/4 X 4 X 1-5/8"
FT6272M
FT6272C
L and R pair



Squat Bunn Foot
3-3/16 X 4-1/2"
CW-SYBF181-M
CW-SYBF181-C



Heavy Fluted Bunn Foot
4-7/8 X 5-3/8"
FT6294-M
FT6294-C



Roped Bunn Foot
4-1/4 X 4-1/2"
CW-SYBF189-M
CW-SYBF189-C



Chunky Bunn Foot
4-1/4 X 4-1/2"
CW-SYBF182-M
CW-SYBF182-C



Woven Bunn Foot
4 X 4-1/2"
CW-SYBF183-M
CW-SYBF183-C



Pedestal Foot Corner
6 X 4-1/2 X 6"
CW-SYPF174-M
CW-SYPF174-C



Beaded Bunn Foot
3-7/8 X 4-1/2"
CW-SYBF176-M
CW-SYBF176-C



Ball & Claw Bunn Foot
3-11/16 X 4-4/12"
CW-SYBF175-M
CW-SYBF175-C



Tulip Bunn Foot
3-1/2 X 4-1/2"
CW-SYBF177-M
CW-SYBF177-C



Country Bunn Foot
4 X 4-1/2"
CW-SYBF178-M
CW-SYBF178-C



Pedestal Foot Corner
6-1/2 X 4-1/2 X 6-1/2"
CW-SYPF173-M
CW-SYPF173-C



Reeded Bunn Foot
4 X 4-1/2"
CW-SYBF184-M
CW-SYBF184-C



Ivy Bunn Foot
4 X 4-1/2"
CW-SYBF185-M
CW-SYBF185-C



Acanthus Bunn Foot
3-1/2 X 4-1/2"
CW-SYBF186-M
CW-SYBF186-C



Coved Bunn Foot
4-3/4 X 4-1/2"
CW-SYBF188-M
CW-SYBF188-C

All Posts are 3-1/2 X 35-1/4 X 3-1/2"
 All Split Posts are 3-1/2 X 35-1/4 X 1-11/16"
 M - Maple C - Cherry SP - Split Post



Vineyard Post
 CW-SYP5031-M
 CW-SYP5031-C
 CW-SYP5031-SPM
 CW-SYP5031-SPC

Acanthus Post
 CW-SYP5032-M
 CW-SYP5032-C
 CW-SYP5032-SPM
 CW-SYP5032-SPC

Rope Post
 CW-SYP5033-M
 CW-SYP5033-C
 CW-SYP5033-SPM
 CW-SYP5033-SPC

Reeded Post
 CW-SYP5034-M
 CW-SYP5034-C
 CW-SYP5034-SPM
 CW-SYP5034-SPC

Queen Ann Post
 CW-SYP5035-M
 CW-SYP5035-C
 CW-SYP5035-SPM
 CW-SYP5035-SPC

Traditional Post
 CW-SYP5036-M
 CW-SYP5036-C
 CW-SYP5036-SPM
 CW-SYP5036-SPC

Large Bar & Kitchen Island Posts
 5" Square X 42" Tall



Rope Post
 CW-SYP5047-C
 CW-SYP5047-M

Traditional Post
 CW-SYP5044-C
 CW-SYP5044-M



*Georgia Hardwoods
Signature Hoods*



Tuscan Country Mantel Hood

RHMM5642-13TUSC 56" w X 42" h X 24-1/4" d Maple
 RHCM5642-13TUSC 56" w X 42" h X 24-1/4" d Cherry

Removable front panel for easy installation
 Uses FI-BUF08W SUS blower and liner
 Shown here in Cherry with Lauren Mahogany Finish and Black glaze.
 Crown moulding not included.
 Want just the carving? See page 43.....



Valance Range Hood

Maple
 RHMA3636 42" w X 36" h X 23" d
 RHMA4236 42" w X 36" h X 23" d
 RHMA4242 42" w X 42" h X 23" d
 RHMA4836 48" w X 36" h X 23" d
 RHMA4842 48" w X 42" h X 23" d
 RHMA5442 54" w X 42" h X 23" d

Cherry
 RHCA3636 42" w X 36" h X 23" d
 RHCA4236 42" w X 36" h X 23" d
 RHCA4242 42" w X 42" h X 23" d
 RHCA4836 48" w X 36" h X 23" d
 RHCA4842 48" w X 42" h X 23" d
 RHCA5442 54" w X 42" h X 23" d

Removable front panel for easy installation
 Corbels and crown sold separately
 Uses FI-BUF06W SUS blower and liner
 Optional FI-FDK0004 Ductless Conversion Kit Available
 Shown in Clear Maple with Black glaze.



Chef Arch Range Hood

Maple

- RHMC3642-12ARCH 36" w X 42" h X 23-1/2" d
- RHMC4242-12ARCH 42" w X 42" h X 23-1/2" d
- RHMC4842-12ARCH 48" w X 42" h X 23-1/2" d

Cherry

- RHCC3642-12ARCH 36" w X 42" h X 23-1/2" d
- RHCC4242-12ARCH 42" w X 42" h X 23-1/2" d
- RHCC4842-12ARCH 48" w X 42" h X 23-1/2" d

Replace ARCH with SQR if desired
 12" high chimney included
 Uses FI-BUFO6W SUS blower and liner
 Shown here in Clear with Black glaze.



Chef Traditional Range Hood

Maple

- RHMC3642-10TRAD 36" w X 42" h X 23-1/2" d
- RHMC4242-10TRAD 42" w X 42" h X 23-1/2" d
- RHMC4842-10TRAD 48" w X 42" h X 23-1/2" d

Cherry

- RHCC3642-10TRAD 36" w X 42" h X 23-1/2" d
- RHCC4242-10TRAD 42" w X 42" h X 23-1/2" d
- RHCC4842-10TRAD 48" w X 42" h X 23-1/2" d

Shown with optional access panel
 12" high chimney included
 Uses FI-BUFO6W SUS blower and liner
 Shown here in Antique White with Van Dyke glaze.
 Want just the carving? See page 43.....



Chef Slab Range Hood

Maple

- RHMC3642-12SLAB 36" w X 42" h X 23-1/2" d
- RHMC4242-12SLAB 42" w X 42" h X 23-1/2" d
- RHMC4842-12SLAB 48" w X 42" h X 23-1/2" d

Cherry

- RHCC3642-12SLAB 36" w X 42" h X 23-1/2" d
- RHCC4242-12SLAB 42" w X 42" h X 23-1/2" d
- RHCC4842-12SLAB 48" w X 42" h X 23-1/2" d

Shown with optional access panel
 12" high chimney included
 Uses FI-BUFO6W SUS blower and liner
 Shown here in Clear with Black glaze.



Chef Slab Range Hood
 Shown with optional Applique.



Chef Palmette Range Hood

Maple

- RHMC3642-12PALM 36" w X 42" h X 23-1/2" d
- RHMC4242-12PALM 42" w X 42" h X 23-1/2" d
- RHMC4842-12PALM 48" w X 42" h X 23-1/2" d

Cherry

- RHCC3642-12PALM 36" w X 42" h X 23-1/2" d
- RHCC4242-12PALM 42" w X 42" h X 23-1/2" d
- RHCC4842-12PALM 48" w X 42" h X 23-1/2" d

Shown with optional access panel
 12" high chimney included
 Uses FI-BUFO6W SUS blower and liner
 Shown here in Antique White with Van Dyke glaze.
 Want just the carving? See page 43.....

Optional FI-FDK-0004 Ductless Conversion Kit Available for all Chef Style Hoods using FI-BUFO6W SUS blower.



Rinceau Mantel Range Hood
Mantel style hood shown made in Cherry with Rinceau carved skirt finished in Lauren Mahogany with Black glaze.



Spice Pullout Option
Corbel Not Included

- Mantel and Niche Hood Options
- RH*-LG-SIDES 9"w X 44-1/2"h X 20-1/4"d
 - RH*-SM-SIDES 9"w X 38-1/2"h X 20-1/4"d
 - RH*-LG-SPICE 9"w X 27"h X 14"d
 - RH*-CORBEL 9"w X 14"h X 11"d
- Corbel Not Included



Niche Range Hood
Shown in Maple with Fruitwood finish and Van Dyke glaze.



Mantel Arch Range Hood
Shown with optional sides and spice Pullout. Crown moulding and corbels are not included.



Mantel Slab Range Hood
Shown with optional sides and corbel blocks. Crown moulding and corbels are not included.



Niche Arch Range Hood
Shown with optional sides and spice Pullout. Crown moulding and corbels are not included.



Niche Slab Range Hood
Shown with optional sides, applique and corbel blocks. Crown moulding, applique and corbels are not included.

Mantel Range Hood

- RH*M4436-10**** 44"w X 36"h X 23-1/4"d
 - RH*M4442-13**** 44"w X 42"h X 23-1/4"d
 - RH*M5036-10**** 50"w X 36"h X 23-1/4"d
 - RH*M5042-13**** 50"w X 42"h X 23-1/4"d
 - RH*M5636-10**** 56"w X 36"h X 23-1/4"d
 - RH*M5642-13**** 56"w X 42"h X 23-1/4"d
- * C for Cherry or M for Maple

**** Replace with ARCH for Arch raised panel valance
Replace with SLAB for solid wood slab valance
Replace with SQR for square raised panel valance

Mantel Hoods with Carved Valances

Rinceau Range Hood Carving

- RH*M5036-10RINC 50"w X 36"h X 23-1/4"d
- RH*M5042-13RINC 50"w X 42"h X 23-1/4"d
- RH*M5636-10RINC 56"w X 36"h X 23-1/4"d
- RH*N5642-13RINC 56"w X 42"h X 23-1/4"d

Traditional Range Hood Carving

- RH*M4436-10TRAD 44"w X 36"h X 23-1/4"d
- RH*M4442-10TRAD 44"w X 42"h X 23-1/4"d
- RH*M5036-10TRAD 50"w X 36"h X 23-1/4"d

Palmette Range Hood Carving

- RH*M4442-13PALM 44"w X 42"h X 23-1/4"d
 - RH*M5042-13PALM 50"w X 42"h X 23-1/4"d
 - RH*M5642-13PALM 56"w X 42"h X 23-1/4"d
- Traditional and Palmette carvings shown on PG43.

Niche Range Hood

- RH*N4436-10**** 44"w X 36"h X 23-1/4"d
 - RH*N4442-13**** 44"w X 42"h X 23-1/4"d
 - RH*N5036-10**** 50"w X 36"h X 23-1/4"d
 - RH*N5042-13**** 50"w X 42"h X 23-1/4"d
 - RH*N5636-10**** 56"w X 36"h X 23-1/4"d
 - RH*N5642-13**** 56"w X 42"h X 23-1/4"d
- * C for Cherry or M for Maple

**** Replace with ARCH for Arch raised panel valance
Replace with SLAB for solid wood slab valance
Replace with SQR for square raised panel valance

Niche Hoods with Carved Valances

Rinceau Range Hood Carving

- RH*N5036-10RINC 50"w X 36"h X 23-1/4"d
- RH*N5042-13RINC 50"w X 42"h X 23-1/4"d
- RH*N5636-10RINC 56"w X 36"h X 23-1/4"d
- RH*N5642-13RINC 56"w X 42"h X 23-1/4"d

Traditional Range Hood Carving

- RH*N4436-10TRAD 44"w X 36"h X 23-1/4"d
- RH*N4442-10TRAD 44"w X 42"h X 23-1/4"d
- RH*N5036-10TRAD 50"w X 36"h X 23-1/4"d

Palmette Range Hood Carving

- RH*N4442-13PALM 44"w X 42"h X 23-1/4"d
 - RH*N5042-13PALM 50"w X 42"h X 23-1/4"d
 - RH*N5642-13PALM 56"w X 42"h X 23-1/4"d
- Carvings shown on PG43.

Niche & Mantel Range Hoods

All Are Available in Cherry and Maple
All use the FI-BUF06W SUS blower and liner.
FI-FDK-0004 Ductless Conversion Kit Available.
Crown moulding shown is not included.

Additional options available are side columns,
spice pullouts and corbel blocks.

Stop by our showroom to see a display of all our range hoods.



Classic Square Range Hood

Maple

RHM3024-CLAS 30" w X 24" h

RHM3624-CLAS 36" w X 24" h

Cherry

RHC3024-CLAS 30" w X 24" h

RHC3624-CLAS 36" w X 24" h

Uses FI-BUF021A SUS or FI-BUF02A SUS blower and "T" style liner.

FI-FDK-021 and FI-FDK-02A

Ductless conversion kit available.

Shown with Optional:

Wood ornament

Vertical wood mouldings

Spindle rail package



Classic Chef Range Hood

Maple

RHM3024-CHEF 30" w X 23-1/2" h X 8-5/16" d

RHM3624-CHEF 36" w X 23-1/2" h X 8-5/16" d

Cherry

RHC3024-CHEF 30" w X 23-1/2" h X 8-5/16" d

RHC3624-CHEF 36" w X 23-1/2" h X 8-5/16" d

Shown with optional galley rail and vertical moulding

Uses FI-BUF021A SUS or FI-BUF02A SUS blower

"T" style liner see page 44.

FI-FDK-021 and FI-FDK-02A ductless conversion kit available.

Shown with optional spindle rail package



Tuscan Country Range Hood Carving

RH6075C Cherry

RH6075M Maple

Carving is 65" w X 15-1/2" h X 1-1/4" thick

Carving includes 2 side pieces: 30" w X 15-1/2" h X 1-1/4" thick
Crown Moulding Not Included



Palmette Range Hood Carving

RH6084C Cherry

RH6084M Maple

Carving is 62-1/8" w X 12" h X 1-1/4" thick

Carving includes 2 side pieces: 33" w X 9-5/8" h X 1-1/4" thick
Crown Moulding Not Included



Traditional Range Hood Carving

RH6080C Cherry

RH6080M Maple

Carving is 72" w X 9-5/8" h X 1-1/4" thick

Carving includes 2 side pieces: 30" w X 9-5/8" h X 1-1/4" thick
Crown Moulding Not Included



FI-BUF-02A Compact Stainless Steel Blower

- 370/350 CFM (0.01 0.1"wg), 7.0 Sones (BUF-02A)
- 50 Watt halogen lamp (MR16, GU10)
- 3 speed switch with Pilot Lamp



FI-BUF-021 Pro Style Mini Stainless Steel Blower

- 370/350 CFM (0.01 0.1"wg), 7.0 Sones (BUF-021)
- Two 35 Wall halogen lamp (MR16, GU10)
- 3 speed switch with Pilot Lamp

BUF 02A and BUF 021 Liners Wall Mount

- FI-FU9092 SUS 30" T Style Liner
- FI-FU9095 SUS 36" T Style Liner
- FI-FU9106 SUS 30" Rectangular Liner
- FI-FU9107 SUS 36" Rectangular Liner
- FI-FU9141 SUS 42" Rectangular Liner
- FI-FU9144 SUS 48" Dual Rectangular Liner*

*Mounts Dual 021 Blowers

All liners are Clear Powder Coated Stainless Steel



FI-BUF-06w Pro Style Wall Mount

FI-BUF-06p Pro Style Peninsula

- 1320/1280 CFM (0.0/0.1"wg), 8.0 Sones; 56 dB(A)
- Dual Control: 3 speed switch with Pilot Lamps
- 50 Watt x 2 Halogen Lamps (PAR20)
- Clear Powder Coat Stainless Steel

BUF 06W Stainless Steel Liners Wall Mount

- FI-FU9040 SUS 36" Liner
- FI-FU9041 SUS 42" Liner
- FI-FU9042 SUS 48" Liner
- FI-FU9043 SUS 54" Liner

BUF 06W Stainless Steel Liners Mantel

- FI-FU9045 SUS 36" Liner
- FI-FU9046 SUS 42" Liner
- FI-FU9047 SUS 48" Liner
- FI-FU9048 SUS 54" Liner

BUF 06W Stainless Steel Liners Peninsula

- FI-FU9036 SUS 36" Liner
- FI-FU9037 SUS 42" Liner
- FI-FU9038 SUS 48" Liner



FI-ECW360 SUS Stainless Steel Chef Style

- 36" w X 24" d X 33 to 46-7/8" h
- 600CFM / 6.0 Sones Blower
- Optional FI-FU9133 Trim Ring for Chimney
- 50 Watt x 2 Halogen Lamps (PAR20)



FI-FSR-3600 SUS Stainless Steel Undermount

36" w X 6" h X 22-1/2" d 300CFM / 6 Sones Blower



FI-BUF-08w Pro Series Stainless Steel Blower

FI-9192 SUS 60" Stainless Liner

- 1320/1280 CFM (0.0/0.1"wg), 8.0 Sones; 56 dB(A)
- Dual Control: 3 speed switch with Pilot Lamps
- 50 Watt x 3 Halogen Lamps (PAR20)



Ductless Conversion Kits

- FI-FDK-0004 for FSR and BUF06 \$64.00
- FI-FDK-021 for BUF021 blowers \$64.00
- FI-FDK-02A for BUfo2A blowers \$64.00



FI-FPC-0001 Retrofit power cord \$18.00

*for use when 110 outlet is available

MDF

- 62305 1/8" 4x8' A Grade
- 62307 1/8" 5x8' A Grade
- 60300 1/8" 4x8' White 1/S Paint
- 60302 1/8" 5x8' White 1/S Paint
- 62327 1/4" 4x8' A Grade
- 62327F 1/4" 4x8' A Grade Tempered
- 62328 1/4" 5x8' A Grade
- 62328F 1/4" 5x8' A Grade Tempered
- 62312 1/4" 4x8' Beaded 1-1/2"OC
- 60301 1/4" 4x8' White 1/S Paint
- 60303 1/4" 5x8' White 1/S Paint
- 62317 3/8" 4x8' A Grade
- 62315 1/2" 4x8' A Grade
- 62362 1/2" 4x8' Door Grade Dbl/Ref
- 62364 1/2" 5x8' Shop Grade
- 62318 5/8" 4x8' A Grade
- 62348 5/8" 4x8' Door Grade Dbl/Ref
- 62366 5/8" 4x8' Shop Grade
- 62335 5/8" 5x8' A Grade
- 62321 3/4" 4x8' A Grade
- 62361 3/4" 4x8' Shop Grade
- 62344 3/4" 4x8' Ranger
- 62340 3/4" 4x8' Door Grade Dbl/Ref
- 62322 3/4" 5x8' A Grade
- 62346 3/4" 5x8' Ranger
- 62341 3/4" 5x8' Door Grade Dbl/Ref
- 62344 3/4 x 11-1/4 x 193" Shelving
- 62345 1" 4x8' A Grade



MDF



1/4" Beaded MDF



Particle Board



1/4" MDF Painted 1/S



Lauan



Okoume



Cork Faced Homasote

Lauan

- 61305 1/8" 4x8'
- 61307 1/4" 4x8'
- 60299 1/4" 4x8' White 1/S Vinyl
- 61207 3/8" 8x4' Bending Barrel
- 60490 1/2" 4x8' White 1/S Vinyl
- 60501 3/4" 4x8' White 1/S Vinyl
- 60502 3/4" 4x8' White 2/S Vinyl

Okoume

- 61302 1/2" 4x8'
- 61303 3/4" 4x8'

Particle Board

- 67372 3/4" 4x8'

Cork Homasote

- 62500 1/2" 4x8' Cork Faced

Shoda Router running door grade MDF



www.pbmdf.com

OC - On Center

1/S - Coated 1 side

Dbl/Refin - Double Refined Board



45,000 SqFt Plywood Warehouse



Alder

01405 Superior Alder
 01405RUS 4/4 Rustic Alder
 01404 4/4 Superior 1/Face Alder
 01600 6/4 Superior Alder
 01800 8/4 Superior Alder

Ash

02400 4/4 FAS Ash
 02800 8/4 FAS Ash

Basswood

03400 4/4 FAS Basswood
 03800 8/4 FAS Basswood

Beech

04400 4/4 Sel&Btr Steamed Beech
 04800 8/4 Sel&Btr Steamed Beech

Birch

04405 4/4 Sel&Btr Birch

Cherry

05400 4/4 FAS Cherry
 05500 8/4 FAS Cherry
 05800 8/4 FAS Cherry

Cypress

06408 1 X 8 Cypress

Hickory

07400 4/4 FAS Hickory
 07401 4/4 #1C Hickory
 07800 8/4 FAS Hickory

Mahogany

09405 4/4 FAS Mahogany
 09500 5/4 FAS Mahogany
 09800 8/4 FAS Mahogany

Maple, Hard

08405 4/4 Sel&Btr Hard Maple
 08500 5/4 Sel&Btr Hard Maple
 08800 8/4 Sel&Btr Hard Maple

Maple, Soft

16405 4/4 Sel&Btr Soft Maple
 15401 4/4 #1C Soft Maple Paint Grade
 15411 4/4 #1C Soft Maple 80% White 1/Face
 16402 4/4 Sel&Btr Soft Maple Curly
 15500 5/4 Sel&Btr Soft Maple
 15800 8/4 Sel&Btr Soft Maple

Maple, Red

14400 4/4 Pacific Red Maple

Oak, Red

12400 4/4 FAS Red Oak Northern
 12402 4/4 FAS Riftsawn
 12404 4/4 FAS Quartersawn
 12410 4/4 FAS Red Oak 10 & Wider
 11500 5/4 FAS Red Oak
 12800 8/4 FAS Red Oak

Oak, White

20400 4/4 FAS White Oak
 20800 8/4 FAS White Oak

Poplar

10400 4/4 FAS Poplar
 10401 4/4 #1C Poplar
 10410 4/4 FAS Poplar 10 & Wider
 10500 5/4 FAS Poplar
 10600 6/4 FAS Poplar
 10800 8/4 FAS Poplar

Walnut

17400 4/4 Sel&Btr Walnut
 17800 8/4 Sel&Btr Walnut

White Pine

25003 3/4 X 11-1/4 #3 Shelving
 18400 4/4 Furniture Grade Pine
 19400 4/4 Moulding Grade Pine
 18800 8/4 Furniture Grade Pine

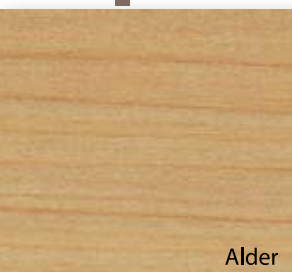

Alder



Ash



Basswood

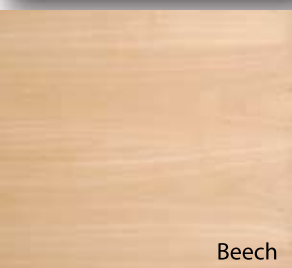

Beech



Birch

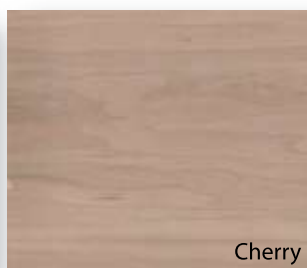

Cherry



Cypress

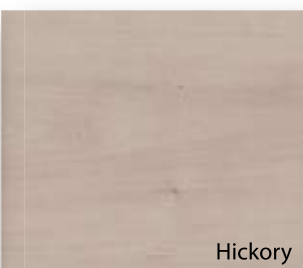

Hickory

Ash

- 57271 1/4" B-4 P/S V/C
- 58274 3/4" B-2 P/S V/C

Alder

- 51210 1/4" B-2 P/S MDF Core
- 51206 1/4" A-2 P/S Bead 1 1/2" OC MDF
- 51208 1/4" A-4 P/S Bead 1 1/2" OC
- 51305 3/4" B-C P/S V/C

Beech

- 61367 1/4" A-4 P/S Steamed
- 61638 3/4" A-C P/S Steamed

Birch, White

- 52245 1/4" B-2 V/C
- 52260 1/4" C-4 V/C
- 61362 1/4" C-2 V/C Import
- 52261 1/4" B-2 MDF Core
- 52262 1/4" B-1 Bead 1 1/2" OC MDF
- 51204 1/4" B-2 Bead 1 1/2" OC V/C
- 51200 1/4" B-4 Bead 1 1/2" OC V/C
- 52236 1/2" B-2 V/C
- 61363 1/2" C-2 V/C Import
- 52237 1/2" C-3 V/C
- 52238 1/2" B-2 MDF Core
- 51413 1/2" 4x10' C-2 V/C Import
- 52239 3/4" B-2 V/C
- 61361 3/4" C-2 V/C Import
- 61364 3/4" C-2 V/C Import
- 52242 3/4" B-2 MDF Core
- 51413 3/4" 4x10' C-2 Import V/C

Birch, Natural

- 51234 1/4" B-2 V/C
- 51240 1/4" C-4 V/C
- 61342 1/4" C-D V/C Import
- 51232 1/2" B-2 V/C
- 51223 1/2" C-3 V/C
- 61343 1/2" C-D V/C Import
- 51224 3/4" B-2 V/C
- 51225 3/4" C-3 V/C
- 61344 3/4" C-D V/C Import
- 51226 3/4" B-2 MDF Core
- 51230 3/4" D-3 V/C

Birch, White Prefinished

- 51267 1/4" C-D V/C 1/S
- 51268 1/2" C-D V/C 1/S
- 51269 1/2" C-D V/C 2/S
- 51410 1/2" 4x10' C-2 V/C 1/S
- 51261 3/4" C-D V/C 1/S
- 51266 3/4" C-D V/C 2/S
- 51411 3/4" 4x10' C-2 V/C 1/S
- 51412 3/4" 4x10' C-2 V/C 2/S

Birch, Natural Prefinished

- 51400 1/4" C-4 V/C 1/S
- 51401 1/2" D-3 V/C 2/S
- 51402 3/4" D-3 V/C 1/S
- 51403 3/4" D-3 V/C 2/S

Birch, Red

- 51280 1/4" C-2 V/C
- 51280CR 1/4" B-C V/C Import
- 50224 1/4" B-2 Bead 1 1/2" OC V/C
- 51281 1/2" B-C V/C Import
- 51278 3/4" C-2 V/C Import
- 51278CR 3/4" B-C V/C Import

Birch, Russian

- 61318 1/4" (6mm) 5x5 BB/CP
- 61319 1/2" (12mm) 5x5' BB/CP
- 61320 1/2" (12mm) 4x8' C-2
- 61322 3/4" (18mm) 5x5' BB/CP

Cherry

- 54255 1/4" B-2 P/S V/C
- 54254 1/4" B-4 P/S V/C
- 54275 1/4" B-1 MDF Core
- 54277 1/4" B-1 Bead 1 1/2" OC MDF
- 54252 1/4" B-2 Bead 1 1/2" OC V/C
- 54257 1/2" B-2 P/S V/C
- 54256 3/4" B-2 P/S V/C
- 54263 3/4" A-1 P/S V/C
- 53264 3/4" Shop P/S V/C
- 54260 3/4" B-2 P/S MDF Core
- 54272 3/4" 4x10' B-2 P/S V/C

Hickory

- 49100 1/4" B-2 P/S V/C
- 49102 1/4" B-4 P/S Beaded 1 1/2" OC
- 49103 1/4" B-1 P/S MDF Core
- 49110 3/4" B-2 P/S V/C

Maple

- 53250 1/4" B-2 V/C
- 53262 1/4" C-4 V/C
- 53274 1/4" B-2 MDF Core
- 53271 1/4" B-2 Bead 1 1/2" OC MDF
- 53261 1/4" B-2 Bead 1 1/2" OC V/C
- 53263 1/4" B-4 Bead 1 1/2" OC V/C
- 61308 1/4" B-4 V/C Import
- 53277 1/4" C-4 V/C Import
- 53256 1/2" B-2 V/C
- 53280 1/2" C-2 V/C Import
- 61378 1/2" B-2 V/C Import
- 53251 3/4" B-2 V/C
- 53252 3/4" Shop V/C
- 53255 3/4" B-2 MDF Core
- 61369 3/4" B-2 V/C Import
- 53278 3/4" C-2 V/C Import
- 53258 3/4" 4x10' B-3 V/C

Maple, Prefinished

- 53300 1/4" B-4 V/C 1/S
- 53301 1/2" B-2 V/C 2/S
- 53302 3/4" B-2 V/C 2/S
- 53272 3/4" C-2 V/C 2/S

Mahogany

- 55260 1/4" B-2 P/S V/C
- 55261 3/4" B-2 P/S V/C

Oak, Red

- 50213 1/4" B-2 V/C
- 50200 1/4" B-4 V/C
- 52201 1/4" B-2 MDF Core
- 50208 1/4" B-2 Bead 1 1/2" OC V/C
- 50209 1/4" B-4 Bead 1 1/2" OC V/C
- 50205 1/2" C-3 V/C
- 50207 3/4" B-2 V/C
- 50210 3/4" Shop V/C
- 50216 3/4" B-2 MDF Core
- 61401 3/4" C-2 Import V/C

Oak, White

- 50218 1/4" B-2 V/C
- 50217 3/4" B-2 V/C

Poplar

- 61352 1/4" C-D White V/C Import
- 61353 1/2" B-C White V/C Import
- 61354 3/4" B-C White V/C Import

Walnut

- 59278 1/4" B-2 P/S V/C
- 59279 3/4" B-2 P/S V/C

White Pine

- 56265 1/4" B-2 P/S V/C
- 56260 1/4" C-4 P/S V/C
- 56263 1/4" B-2 P/S Bead 1 1/2" OC V/C
- 56267 3/4" B-2 P/S V/C

P/S - Plain Sliced Veneer
 V/C - Veneer Core
 OC - On Center
 1/S - UV Coated 1 side
 2/S - UV Coated 2 sides

All Plywood 4x8' Unless Noted

Walnut

White Pine

Poplar

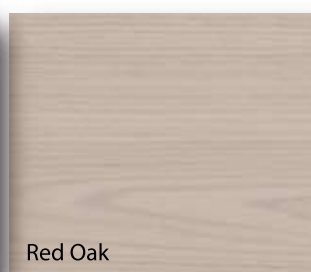
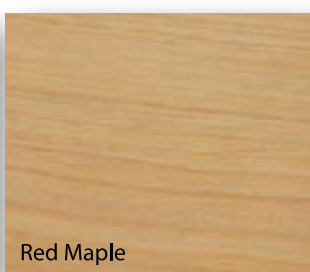
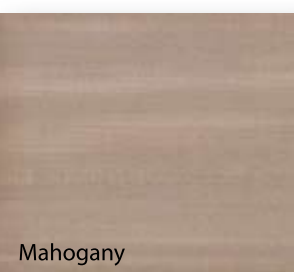

Mahogany

Maple

Red Maple

Red Oak

White Oak



* Denotes Special Order



* Denotes Special Order

Paper - 10mil Paper Back

HPL - High Pressure Laminate

WOW - Wood On Wood



R O S E B U R G

DURAMINE®

Decorative Melamine

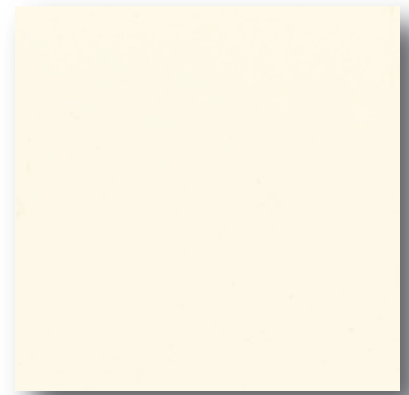

Antique White #109
ME-ANTW



Oxford White #11
ME-OXWH



Black #06
ME-BLAC

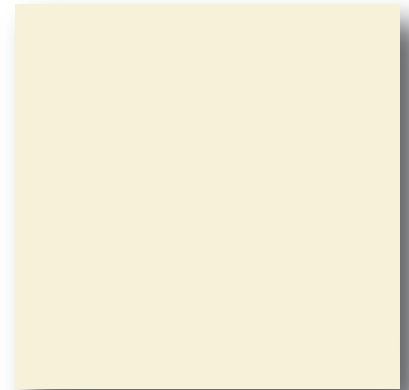

Almondine #16
ME-ALMD



Wild Apple #665
ME-WAPL



Chocolate Cherry #706
ME-CHCH



Hardrock Maple #55
ME-HROC



Chocolate Apple #663
ME-CHAP



Noce D'Autore #702
ME-NOCE



Mahogany Impressions #404
ME-MHIM

PVC Edgebanding



333' X 13/16" Pre-glued

- 81015 Almond
- 81025 Black
- 81039 Lucca Cherry (15/16" X 300')
- 81035 White

Automatic Edgebanding

- 81002 Almond 600' X 7/8"
- 81003 Black 600' X 7/8"
- 81044 Hard Rock Maple 600' X 15/16"
- 81041 Lucca Cherry 600' X 15/16"
- 81001 White 600' X 7/8"
- 81004 White 600' X 15/16"

Poly/PVC Edgebanding 50' X 13/16" Pre-glued

- 81010 Almond
- 81020 Black
- 81030 White

Wood Edgebanding



250' X 13/16" Preglued

- 81165 Alder
- 81141 Ash
- 81085 Birch
- 81401 Birch Prefinished
- 81105 Cherry
- 81092 Hickory/Pecan
- 81135 Maple
- 81115 Mahogany
- 81125 Red Oak
- 81095 Walnut
- 81134 White Pine

50' X 13/16" Preglued

- 81170 Alder
- 81140 Ash
- 81080 Birch
- 81100 Cherry
- 81092 Hickory/Pecan
- 81130 Maple
- 81110 Mahogany
- 81120 Red Oak
- 81090 Walnut
- 81133 White Pine

500' X 7/8" Automatic

- 81345 Alder
- 81140 Ash
- 81305 Birch
- 81402 Birch Prefinished
- 81310 Cherry
- 81340 Hickory/Pecan
- 81300 Maple
- 81315 Mahogany
- 81325 Red Oak
- 81335 White Pine

Prefinished 81401 250' X 7/8" Pre-finish Wh. Birch Glued
81402 500' X 7/8" Pre-finish Wh. Birch Auto



Prefinished Fastedge 50'

- FC-EDGE-PSM50 Maple
- FC-EDGE-PWB50 White Birch

Unfinished Fastedge 50'

- FC-EDGE-CH50 Cherry
- FC-EDGE-MAH50 Mahogany
- FC-EDGE-NB50 Nat. Birch
- FC-EDGE-PIN50 Pine
- FC-EDGE-RO50 Red Oak
- FC-EDGE-SM50 Maple
- FC-EDGE-WAL50 Walnut
- FC-EDGE-WB50 White Birch

PVC Fastedge 50'

- FC-EDGE-AL50 Almond
- FC-EDGE-AW50 Antique White
- FC-EDGE-BL50 Black
- FC-EDGE-HM50 H. Rock Maple
- FC-EDGE-MM50 Manitoba Maple
- FC-EDGE-WH50 White



Made with FastCaps high performance pressure sensitive acrylic adhesive that increases in strength as it cures, providing a long lasting permanent bond.



- FC-Q.TRIM Quad Trimmer Carbon Blade
- FC-QPRO.TRIM Quad Trimmer Tungsten Carbide
- FC-QPRO-BLADE Carbide Replacement Blade

Super smooth action with comfortable ergonomic design and can trim in all directions.

SpeedRoller PRO



- FC-SPEEDROLL Speed Roller Pro

Includes two non-marring rubber wheels and two metal wheels for maximum PSI.



Prefinished Wood Fastcaps 9/16"

FC-PW-916M-SM	Maple	260/PK
FC-PW-916M-WB	W. Birch	260/PK
FC-PW-916S-SM	Maple	1040/PK
FC-PW-916S-WB	W. Birch	1040/PK

Unfinished Wood Fastcaps 9/16"

FC-SW-916M-CH	Cherry	260/PK
FC-SW-916M-MAH	Mahogany	260/PK
FC-SW-916M-NB	Nat. Birch	260/PK
FC-SW-916M-PN	Pine	260/PK
FC-SW-916M-RO	Red Oak	260/PK
FC-SW-916M-SM	Maple	260/PK
FC-SW-916M-WAL	Walnut	260/PK
FC-SW-916M-WB	W. Birch	260/PK
FC-SW-916S-NB	Nat. Birch	1040-PK
FC-SW-916S-SM	Maple	1040/PK
FC-SW-916S-WB	W. Birch	1040/PK

PVC Fastcaps 9/16"

FC-SP-916M-AL	Almond	260/PK
FC-SP-916M-AW	Antique White	260/PK
FC-SP-916M-BL	Black	260/PK
FC-SP-916M-HM	H. Rock Maple	260/PK
FC-SP-916M-MM	Manitoba Maple	260/PK
FC-SP-916M-WH	White	260/PK
FC-SP-916S-BL	Black	1040/PK
FC-SP-916S-HM	H. Rock Maple	1040/PK
FC-SP-916S-WH	White	1040/PK

Micro FLUSHMOUNT

Drill Bit System



FC-FLUSHDRILL Flushmount Drill Bit

With ball bearing stop collar to control recess depth for the perfect countersunk hole. This bearing system allows the collar to stop spinning when it comes in contact with the wood surface to prevent marring. Also comes in complete punch kit below.



FC-PUNCHKIT

Custom Color Punch Kit

Custom Color Punch Kit includes: Micro FlushMount Drill Bit, 1" X 50' SpeedTape, PowerHead Screws, Punch Tool, 9/16", 11/16", 3/8" dies all in a Hard-Shell Carrying Case

FC-PUNCH

Single Hole Punch

Includes everything in punchkit minus Flushmount drill bit.



FC-SPDTAPE1	1" X 50' Speed Tape
FC-SPDTAPE1.5	1.5" X 50' Speed Tape
FC-SPDTAPE2	2" X 50' Speed Tape

High quality peel and stick on a roll. Used for veneers and laminates, just peel off the liner and stick it.

POWERHEAD screws



#8 Screws with 9/16" head that accepts a #2 square drive bit and type 17 tip. Nibs on the bottom of the head help cut through the material to allow for the perfectly flush finish to the materials surface.



FC-WPWRHEAD112	1.125"	200/PK
FC-WPWRHEAD125	1.25"	200/PK
FC-WPWRHEAD250	2.5"	150/PK
FC-WPWRHEAD300	3"	150/PK
FC-WPWRHEAD350	3.5"	100/PK

AccuScribe^{PRO}
SCRIBING TOOL



FC-SCRIBE AccuScribe Pro Tool

pro
HOLD



FC-PROHOLD



Pro Hold Magnetic Screw Holder

FastBreak



FC-FASTBREAK
FC-FAST 80
FC-FAST 180

Fastbreak Sander
Fast Break 80 Grit Paper
Fast Break 180 Grit Paper

DRAWER BUMPER

CABINET DOOR PROTECTOR



FC-DRAWERBMP

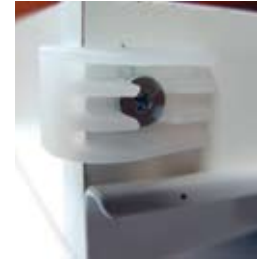

Self-Adhesive Drawer Bumper 10pk

FASTWRAP



FC-FASTWRAP Double Sided Hook & Loop Roll 10' length

SPEEDOLLIE



FC-SPEEDDOLL



The Speed Dollie can be used by anyone for moving heavy awkward items. Lightweight and compact, the Speed Dollie is constructed with durable aluminum and has a 250lbs. capacity.

KOLBE KORNER



Easily mount Shaker and Euro drawer fronts.

FC-KK50CM Kolbe Korner Clear Maple 50/PK
FC-KK50LM Kolbe Korner Lt. Maple 50/PK
FC-KK50WH Kolbe Korner White 50/PK



FC-CONVERTER

Converter Pro Calculator easily converts between imperial, metric and fractions in seconds. Also contains an erasable notepad.

TriBlade



FC-TRIKNIFE TriBlade Knife
FC-TRIBLADE Refill Blades 10/PK

Retractable snap-off blade with an auto-locking mechanism on the blade for strength and security.

SpeedClip



FC-SPEEDCLIP
Speed Clip Belt Clip
For Tape Measures & Pencils

GluBot



Unique design that sucks the glue back into the bottle to keep tip clean. Glue not included.

Glu-Bot Guide

- | | |
|--------------|------------------------------|
| FC-GLUBOT | Glu-Bot 100oz Glue Bottle |
| FC-GLUADAPT | Glu-Bot Adapter |
| FC-GLUBLADE | Glu-Bot Blade Tip 5/PK |
| FC-GLUYORK | Glu-Bot Yorker Tip 5/PK |
| FC-GLUGUIDE | Glu-Bot Guide |
| FC-GLURCAP | Glu-Bot Spare Red Caps 5/PK |
| FC-BABEBOT | Babe-Bot 40z Glue Bottle |
| FC-BABEBLADE | Babe-Bot Blade Tip 5/PK |
| FC-BABEYORK | Babe-Bot Yorker Tip 5/PK |
| FC-BABERCAP | Babe-Bot Spare Red Caps 5/PK |

2P-10

Adhesive System



Complete Kit

- | | |
|----------------|--|
| FC-2P10-KIT | 2P-10 Complete Kit
Kit includes (1) 2oz Jel, (1) 2oz Thick, (1) 2oz Medium, (1) 2oz Thin, Microtips, (1) 2oz Activator, (1) 2 oz Debonder all in a Hardshell Case |
| FC-2P10-ACT12 | 12oz 2P-10 Activator |
| FC-2P10-ACT2 | 2oz Activator Refill |
| FC-2P10-DEBND2 | 2oz Debonder Refill |
| FC-2P10-JEL2 | 2oz Jel Refill |
| FC-2P10-MED2 | 2oz Medium Refill |
| FC-2P10-THK2 | 2oz Thick Refill |
| FC-2P10-THIN2 | 2oz Thin Refill |
| FC-2P10-MICRO | Spare Micro tips 25/PK |
| FC-2P10-PIN | Spare Pin Caps 5/PK |



- Standard Tape Measure
FC-PS-16 16'
FC-PS-25 25'



- Standard Story Pole Tape Measure
FC-PSSP-16 16'
FC-PSSP-25 25'
Writable/Eraseable area on blade

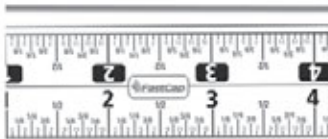

- Standard Reverse Tape Measure
FC-PSSR-16 16' Lefty/Righty
FC-PSSR-25 25' Lefty/Righty



- Metric Standard Tape Measure
FC-PMS-16 16'
FC-PMS-25 25'



- Flat Back Tape Measure
FC-PMS-FLAT16 16' Metric/Standard
FC-PSSP-FLAT16 16' Story Pole
Lays flat to measure curves and radii.



- Peel & Stick Tape Measure
FC-PMS-L12 12' Left Metric/Std
FC-PMS-R12 12' Right Metric/Std
FC-PSSP-L12 12' Left Story Pole
FC-PSSP-R12 12' Right Story Pole

MXV DUST MASK

max exhale valve



- | | |
|--------------|------------------------|
| FC-MXV-MASK | MXV Dust Mask 10/PK |
| FC-MXV-PKT | MXV Pocket Mask 10/PK |
| FC-MXV-PKTEA | MXV Pocket Mask Single |

CatEyes Safety Glasses



- | | |
|------------------------------------|----------------------------|
| FC-SG-AMBER | Safety Glasses Amber |
| FC-SG-CLEAR | Safety Glasses Clear |
| FC-SG-MIRROR | Safety Glasses Mirrored |
| Safety Glasses with diopter lenses | |
| FC-SG-MAG1.5 | 1.5 Diopter Safety Glasses |
| FC-SG-MAG2.0 | 2.0 Diopter Safety Glasses |
| FC-SG-MAG2.5 | 2.5 Diopter Safety Glasses |
| FC-SG-MAG3.0 | 3.0 Diopter Safety Glasses |

Titebond Original Glue



TB-16OZ 16 Ounces
 TB-1G 1 Gallon
 TB-5G 5 Gallons

Titebond II Weatherproof Glue



TB2-16OZ 16 Ounces
 TB2-1G 1 Gallon
 TB2-16OZ-DARK 16 Ounces Dark Wood
 TB2-16OZ-FLUOR 16 Ounces Fluorescent

Moulding & Trim Glue



TBMLD-16OZ 16 Ounces

Titebond Carpenters Glue



TB-CARP-1G 1 Gallon
 TB-CARP-2G 5 Gallons
 F60003 Empty Glue Bottle
 with Yorker cap

Titebond III Waterproof Glue



TB3-16OZ 16 Ounces
 TB3-1G 1 Gallon

Titebond Polyurethane Glue



TB-POLY-4OZ 4 Ounces
 TB-POLY-16OZ 16 Ounces



The HIPUR Advanced Bonding System offers three adhesives, all of which are waterproof and provide strong, permanent bonds.

The HIPUR Kit includes one cartridge each of the WW30, the WW60, and the MP75 glue, and adhesive applicator, an adhesive applicator base (charger), a detachable power cord and a carrying case.

TB-HIPUR-KIT
 Titebond HIPUR Glue Gun Kit

TB-HIPUR-WW30
 50g HIPUR 30 Second Wood to Wood Glue

TB-HIPUR-WW60
 50g HIPUR 60 Second Wood to Wood Glue

TB-HIPUR-MP75
 50g HIPUR 75 Second Multi-Purpose Glue

Door and Drawer Bumpers



90262
 BS-33SD Quiet Bumper
 0.5 X 0.15"
 200 pcs/sheet

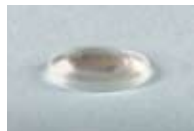

90260
 BS-5SD Round Bumper
 0.5 X 0.25"
 200 pcs/sheet



90263
 BS-40SD Round Bumper
 0.25 X 0.062"
 272 pcs/sheet



90261
 BS-7SD Round Bumper
 0.335 X 0.085"
 203 pcs/sheet

Stretch Wrap



84500
 5" X 1000' X 80ga

Sanding Belts



3 X 21"

- 85705 60 Grit
- 85710 80 Grit
- 85715 100 Grit
- 85720 120 Grit

3 X 24"

- 85905 60 Grit
- 85910 80 Grit
- 85915 100 Grit
- 85920 120 Grit

4 X 24"

- 85805 60 Grit
- 85810 80 Grit
- 85815 100 Grit
- 85820 120 Grit

Sold by the individual belt, 10 belts in a box.

Klingon 5" Hook and Loop



Klingon 5" 5 Hole

- 85145 80 Grit
- 85150 100 Grit
- 85155 120 Grit
- 85160 150 Grit
- 85165 180 Grit
- 85170 220 Grit

Klingon 5" 8 Hole

- 85174 80 Grit
- 85175 100 Grit
- 85180 120 Grit
- 85185 150 Grit
- 85190 180 Grit
- 85195 220 Grit

Klingon 5" No Hole

- 85604 80 Grit
- 85605 100 Grit
- 85610 120 Grit
- 85615 150 Grit
- 85620 180 Grit
- 85625 220 Grit

Sold by the box, 100 disks in a box.

PSA - Peel N Stick



5" PSA

- 85504 80 Grit
- 85505 100 Grit
- 85510 120 Grit
- 85515 150 Grit
- 85520 180 Grit
- 85525 220 Grit

6" PSA

- 85550 80 Grit
- 85555 100 Grit
- 85560 120 Grit
- 85575 220 Grit

Sold by the box, 100 disks in a box.

9 X 11" Sheets



- 85405 100 Grit
- 85410 120 Grit
- 85415 150 Grit
- 85420 180 Grit
- 85425 220 Grit
- 85460 320 Grit

Sold by the sheet.

4 X 2-3/4 X 1" Sanding Sponge



- 85355 80 Grit
- 85360 100 Grit
- 85365 120 Grit
- 85375 180 Grit
- 85380 220 Grit

Sold as a pack of 10.
Sanding grit on 4 sides.

Sanding Pads

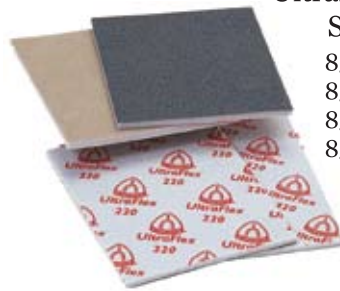

Ultraflex 4-1/2 X 5-1/2" Single Sided

- 85665 120 Grit
- 85675 180 Grit
- 85680 220 Grit
- 85685 320 Grit

Foam Pad 4 X 5" Double Sided

- 85950 60 Grit
- 85955 80 Grit
- 85960 100 Grit
- 85965 120 Grit
- 85970 180 Grit
- 85975 220 Grit

Sold as a pack of 10.

Woodfiller

Pint Wood Filler

- 87100 Alder
- 87015 Birch
- 87025 Cherry
- 87035 Mahogany
- 87080 Maple
- 87095 Natural
- 87005 Red Oak
- 87065 Walnut
- 87105 White
- 87045 White Pine

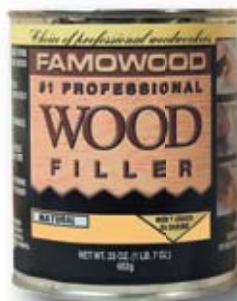

1/4 Pint Wood Filler

- 87060 Ash
- 87020 Birch
- 87030 Cherry
- 87040 Mahogany
- 87085 Maple
- 87090 Oak
- 87010 Red Oak
- 87070 Walnut
- 87050 White Pine



Famosolvent

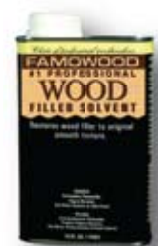

87075 Pint

SoftWax

wax filler system

SoftWax sticks are available individually or in packs of 10. Colors with corresponding numbers shown right in SoftWax Kit.

- FC-WAX01S White
- FC-WAX02S Off White
- FC-WAX03S Med Antique Wht
- FC-WAX04S Light Antique Wht
- FC-WAX05S Light Oak
- FC-WAX06S Med Oak
- FC-WAX07S Dark Oak
- FC-WAX08S Light Cherry
- FC-WAX09S Med Cherry
- FC-WAX10S Dark Cherry
- FC-WAX11S Red
- FC-WAX12S Green
- FC-WAX13S Yellow
- FC-WAX14S Med Walnut
- FC-WAX15S Dark Walnut
- FC-WAX16S Light Walnut
- FC-WAX17S Burnt Orange
- FC-WAX18S Light Mahogany
- FC-WAX19S Dark Mahogany
- FC-WAX20S Ebony
- FC-WAXPAD Wax Buffing Pad Refill
- FC-WAXWEDGE Wax Wedge Refill

SoftWax is a great way to fill holes in finished wood-work. Just fill the hole with one of the 20 blendable colors, remove the excess wax and then buff with a buffing pad.



FC-WAXKIT SoftWax Kit

The refillable kit contains 20 blendable colors, a WaxWedge and a buffing pad all in a hardshell case.



Step 1



Step 2



Step 3





The 3rd Hand HD and the Little 3rd Hand HD are designed to provide support for installing crown and trim moulding, creating dust barriers, hanging drywall overhead and as a load stabilizer. 70lbs. Capacity, 360 degree articulating top and bottom feet.

FC-3RDHAND 3rd Hand HD 5'-12' Extension

FC-MAG FOOT 3rd Hand Dust Barrier Magnet

FC-UNIVFOOT 6" SQ Articulating Foot

FC-HANDBAG 3rd Hand Carrying Bag

FC-LITTLEHAND 3rd Hand Little Hand 16.5"-22.8"



Magnetic foot for dust barrier.



Universal foot allows 3rd hand to freestand.



Micro adjust foot mount

THE JACK

OF ALL TRADES™



The Jack of All Trades is great for lifting base cabinets. It is also a heavy-duty clamp, a lift for installing or adjusting heavy entry doors, or for pulling together hardwood flooring. 70lb capacity, 15.25" lift, Up to 13.3" clamp and 23" spread.

FC-JACK



1332 Anti-Rak Pocket Door



- 75lb load capacity, 3/4 extension
- .88" Side space
- Door heights up to 78"
- Door widths up to 26"
- Hold out detent
- Silenced in and out

- AC-CB1332-12D 12"
- AC-CB1332-14D 14"
- AC-CB1332-16D 16"
- AC-CB1332-18D 18"
- AC-CB1332-20D 20"
- AC-CB1332-22D 22"
- AC-CB1332-24D 24"
- AC-CB1332-26D 26"
- AC-CB1332-28D 28"
- AC-CB1332-30D 30"
- AC-CB1332-32D 32"

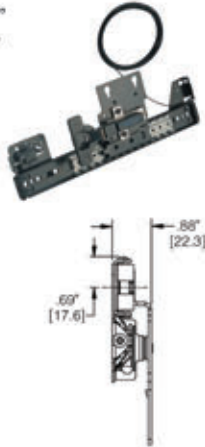

1432 Anti-Rak Pocket Door

- Same as 1332
- Does not include hinges

- AC-CB1432-18D 18"
- AC-CB1432-20D 20"
- AC-CB1432-22D 22"
- AC-CB1432-24D 24"

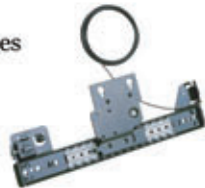

1321 Pro Pocket Door



- 30lb load capacity
- 2.24" Side space
- Full 3/4" Overlay
- Door heights up to 42"
- Door widths up to 24"
- Cover caps
- Auto full extend feature

- AC-CB1321-16D 16"
- AC-CB1321-18D 18"
- AC-CB1321-20D 20"
- AC-CB1321-22D 22"
- AC-CB1321-24D 24"
- AC-CB1321-26D 26"
- AC-CB1321-28D 28"



1332 & 1432 Hinge Carrier Strip

AC-4180-0408-XE

Used for Pocket Doors over 36" in height. Strip allows the mounting of additional hinges required to support tall doors.



123 Pocket Door



- 30lb load capacity
- 1.1" Side space
- Door heights up to 42"
- Door widths up to 24"

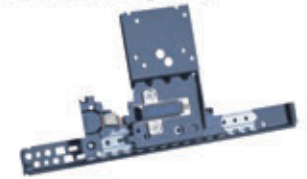

- AC-CB123-12D 12"
- AC-CB123-14D 14"
- AC-CB123-16D 16"
- AC-CB123-18D 18"
- AC-CB123-20D 20"
- AC-CB123-22D 22"
- AC-CB123-24D 24"
- AC-CB123-26D 26"
- AC-CB123-28D 28"

123 Optional Hardware



TTTT TTTT

AC-4180-0313-XE
40mm Salice Clip-on Hinge Kit
For Overlay Application



TTTT TTTT

AC-4180-0314-XE
40mm Salice Clip-on Hinge Kit
For Thick Doors Application

1332 & 1432 Hinge Hardware Kits

1332 Inset Option



AC-4180-0407-XE
For Model 1332
35mm Hinge Kit For
Inset Doors

1432 Overlay Option



AC-4180-0292-XE
For Model 1432
40mm Hinge Kit For
Overlay Doors

1432 Inset Option



AC-4180-0394-XE
For Model 1432
40mm Hinge Kit For
Thick Inset Doors

1155 Easy-Down Flipper Door



- 30lb load capacity
- Doors up to 48" wide
- Protects from rapid door drop
- Includes cylinder cover cap

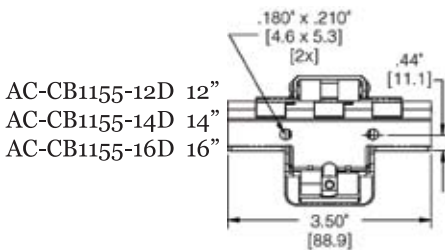

- AC-CB1155-12D 12"
- AC-CB1155-14D 14"
- AC-CB1155-16D 16"

3732 Kitchen & Bath Slide



- 100lb load capacity, full extension
- .50" Side space
- Drawers up to 16" wide
- Push latch disconnect
- Hold in detent
- Low profile side mount
- Enhanced silencing in and out

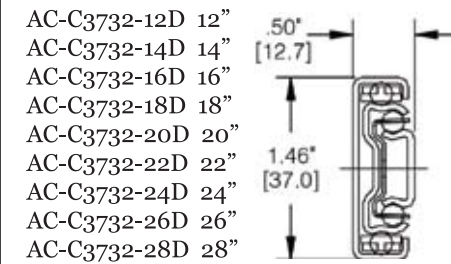

- AC-C3732-12D 12"
- AC-C3732-14D 14"
- AC-C3732-16D 16"
- AC-C3732-18D 18"
- AC-C3732-20D 20"
- AC-C3732-22D 22"
- AC-C3732-24D 24"
- AC-C3732-26D 26"
- AC-C3732-28D 28"

2132 Shallow Drawer Slide



- 75lb load capacity, 3/4 extension
- .50" Side space
- Drawers up to 16" wide
- Lever disconnect
- Hold in detent
- Cam drawer adjust
- Low profile

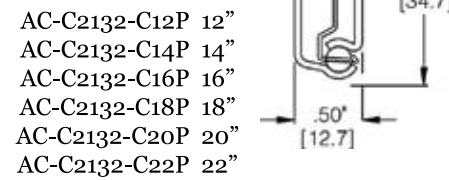

- AC-C2132-C12P 12"
- AC-C2132-C14P 14"
- AC-C2132-C16P 16"
- AC-C2132-C18P 18"
- AC-C2132-C20P 20"
- AC-C2132-C22P 22"

1145 Flipper Door



- 30lb load capacity
- Door width up to 36" wide
- Pin hinge included

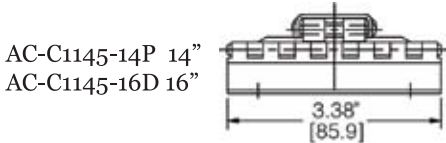

- AC-C1145-14P 14"
- AC-C1145-16D 16"

3732 Series Optional face frame bracket kit



AC-4180-0431-XE

2132 Series Optional face frame bracket kit



AC-4180-0321-XE

1145 And 1155 Series Optional Hardware Kit



AC-4180-0325-XE Zinc Finish
AC-4180-0326-XE Black Finish

2006 Suspended Drawer Slide



- 45lb load capacity, 3/4 extension
- Fixed height bracket install
- .44" Side space
- Drawers up to 16" wide
- Friction disconnect

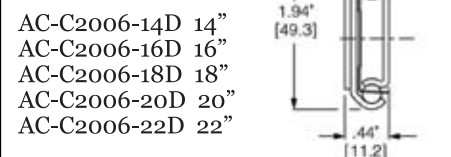

- AC-C2006-14D 14"
- AC-C2006-16D 16"
- AC-C2006-18D 18"
- AC-C2006-20D 20"
- AC-C2006-22D 22"

1029 Centermount Slide



- 35lb load capacity, 3/4 extension
- Drawers up to 16" wide
- Friction disconnect
- No side space requirement
- Single concealed slide

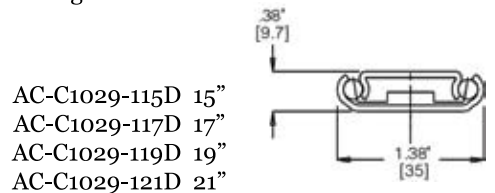

- AC-C1029-115D 15"
- AC-C1029-117D 17"
- AC-C1029-119D 19"
- AC-C1029-121D 21"

3832 Medium Duty Slide

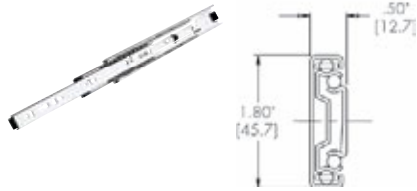

- 100lb load capacity, Full extension
- .50" side space, side mount only
- Cam Drawer Adjust
- Drawers up to 16" wide
- Lever disconnect
- Hold in detent

Individual Packaged / Bulk Pack

- AC-C3832-C10D / C10P 10"
- AC-C3832-C12D / C12P 12"
- AC-C3832-C14D / C14D 14"
- AC-C3832-C16D / C16D 16"
- AC-C3832-C18D / C18D 18"
- AC-C3832-C20D / C20D 20"
- AC-C3832-C22D / C22D 22"
- AC-C3832-C24D / C24D 24"
- AC-C3832-C26D / C26D 26"
- AC-C3832-C28D / C28D 28"

Touch Release

- AC-C3832-C12TRP 12"
- AC-C3832-C14TRP 14"
- AC-C3832-C16TRP 16"
- AC-C3832-C18TRP 18"
- AC-C3832-C20TRP 20"
- AC-C3832-C22TRP 22"
- AC-C3832-C24TRP 24"
- AC-C3832-C26TRP 26"
- AC-C3832-C28TRP 28"

Hold In Detention

- AC-C3832-C14DOP 14"
- AC-C3832-C16DOP 16"
- AC-C3832-C18DOP 18"
- AC-C3832-C20DOP 20"
- AC-C3832-C22DOP 22"

Self-Closing

- AC-C3832-C14SCP 14"
- AC-C3832-C16SCP 16"
- AC-C3832-C18SCP 18"
- AC-C3832-C20SCP 20"
- AC-C3832-C22SCP 22"

Electrocoat Slides

For Use In Extreme Weather Conditions

- AC-EW3832-C18D 18"
- AC-EW3832-C20D 20"
- AC-EW3832-C22D 22"

7434 Commercial Desk or File Slide



- 100lb load capacity
- 1" Overtravel
- .50" side space
- Rail mount/disconnect
- Cam Drawer Adjust
- Drawer widths up to 24"
- Progressive Movement
- Hold in detent

Individually Packaged

- AC-C7434-14D 14" 100lb
- AC-C7434-16D 16" 100lb
- AC-C7434-18D 18" 150lb
- AC-C7434-20D 20" 150lb
- AC-C7434-22D 22" 150lb

Bulk Packaged

- AC-C7434-22X 22" BULK
- AC-C7434-16X 16" BULK
- AC-C7434-18X 18" BULK
- AC-C7434-20X 20" BULK

3832 And 3834 Optional Hardware Kits



AC-4180-0266-XE
For pilaster mounting



AC-4180-0322-XE
Zinc finish only
For face frame mounting.

3017 Wide Desk and Credenza Slide

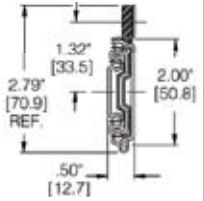

- 100lb load capacity
- 1" Overtravel
- .50" side space
- Rail mount/disconnect
- Drawer widths up to 24"
- Polymer Ball Bearings
- Hold in detent

- AC-C3017-16D 16"
- AC-C3017-18D 18"
- AC-C3017-20D 20"
- AC-C3017-22D 22"

2002 2-Way Pass Through Slide

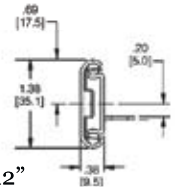

- 50lb load capacity
- 3/4 Extension
- .38" side space
- Drawer widths up to 12"
- Non-disconnect

- AC-C2002-18D 18"
- AC-C2002-20D 20"
- AC-C2002-22D 22"

340 Butcher Block Slide

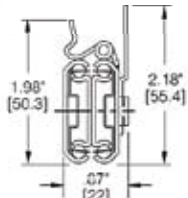

- 110lb load capacity
- Full Extension
- .87" side space
- Drawer widths up to 18"
- Bracket mount disconnect
- Lock-out in open position
- Easy disconnect for cleaning

- AC-C340-249D 16"
- AC-C340-247D 20"
- AC-C340-176D 22"

3640 Lateral File Drawer Slide



- AC-C3640-12D 12"
- AC-C3640-14D 14"
- AC-C3640-16D 16"
- AC-C3640-18D 18"
- AC-C3640-20D 20"
- AC-C3640-22D 22"
- AC-C3640-24D 24"
- AC-C3640-26D 26"
- AC-C3640-28D 28"

- 1" Overtravel
- Drawer widths up to 42"
- .89" side spacing
- Rail mount/disconnect
- Flat mount limits 75lb and 24"
- Hold in detent

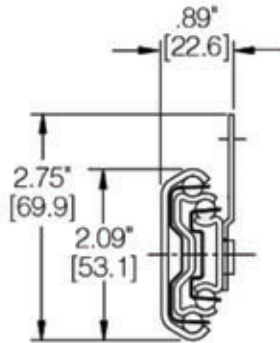

9301 Heavy Duty Slide



- AC-C9301-10P 10"
- AC-C9301-12P 12"
- AC-C9301-14P 14"
- AC-C9301-16P 16"
- AC-C9301-18P 18"
- AC-C9301-20P 20"
- AC-C9301-22P 22"
- AC-C9301-24P 24"
- AC-C9301-26P 26"
- AC-C9301-28P 28"
- AC-C9301-30P 30"
- AC-C9301-32P 32"
- AC-C9301-34P 34"
- AC-C9301-36P 36"
- AC-C9301-40P 40"
- AC-C9301-42P 42"
- AC-C9301-48P 48"
- AC-C9301-60P 60"

- Full Extension
- 150-500lb capacity
- Drawer widths up to 42"
- .75" side spacing
- Non-disconnect
- Silenced in and out
- Hold in detent

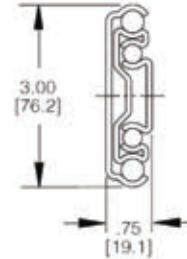

4034 File Drawer Slide

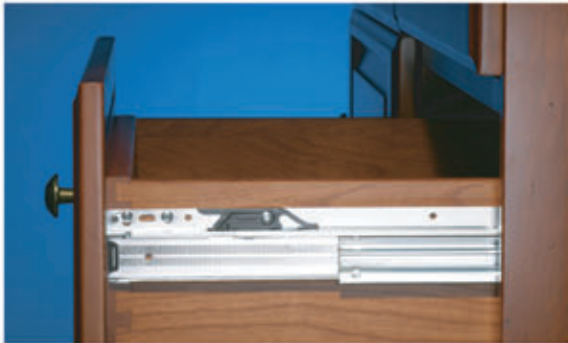

- AC-C4034-C12D 12"
- AC-C4034-C14D 14"
- AC-C4034-C16D 16"
- AC-C4034-C18D 18"
- AC-C4034-C20D 20"
- AC-C4034-C22D 22"
- AC-C4034-C24D 24"
- AC-C4034-C26D 26"

- Bulk pack available 'X'
- 1.5" Overtravel,
- 150lb load capacity
- Drawer widths up to 24"
- 1/2" side spacing
- Rail mount/disconnect
- Cam drawer adjust
- Progressive movement
- Silenced in and out
- Hold in detent

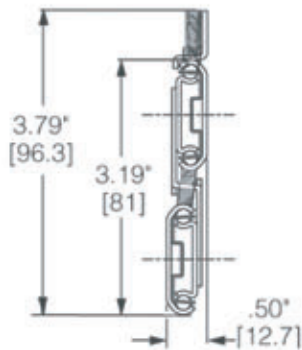

301 Undermount Slide



- AC-C301-259012D 12"
- AC-C301-259014D 14"
- AC-C301-259016D 16"
- AC-C301-259018D 18"
- AC-C301-259020D 20"
- AC-C301-259022D 22"
- AC-C301-259024D 24"

- 3/4" Overtravel
- 130lb capacity
- Drawer widths up to 16"
- Non-disconnect
- 1.54" verticle space req.
- Mounting hardware included

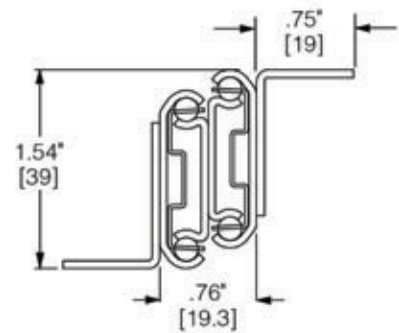

3600 Stowaway Waste Bin Slide



- Stowaway Slide
- 175lb Load Capacity
- Standard 22" Length
- Full Extension
- Two Fixed Brackets

- AC-C3600-201D 1 fixed bracket
- AC-C3600-200D 2 fixed brackets

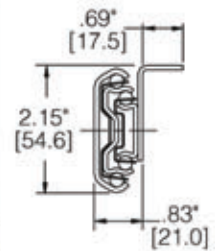



CB MAC Media Access Centers

AC-CBMAC-100
300lb Capacity
Top and bottom swivel
Units up to 55" tall

AC-CBMAC-50
150lb Capacity
Bottom swivel
Units up to 36" tall

- Compatible with EIA mounting standards
- Accommodates shelving units 20-3/4 wide by 18" deep
- Full 20" extension
- Slides and swivel are black powdercoat
- 90 degree rotation in both directions provide full access to the back of the unit
- Rotation function actuates only when slides are fully extended preventing damage
- Detent-in and detent-out holds shelving units securely in place
- Cable management brackets help keep wires clear of the slides
- Cable clips attach to shelves to keep wires neatly bundled at the back of components
- Power strip and cable ties included



CBLift TV Quick Lift

AC-CBLIFT-050

- 120lb Capacity
- Elevates Flat Panel TVs up to 50" Diagonal
- Fits 34" Tall Standard Cabinets
- Minimum cabinet opening 28" w X 10" d
- Pre-mounted to 3/4" plywood backer
- Includes standard and key fob remotes
- Auto reverse mechanism when obstructed
- Cable management

AC-4180-0650-XE
Optional Fixed Lid Bracket Kit

36" and Under TV Swivel



- 225lb Capacity
- 14" Extension
- Up to 36" diagonal
- Hold in detent
- 360° swivel

AC-CB3620-258TV

Flat Panel TV Swivel



- 325lb Capacity
- 22" Extension
- Up to 65" diagonal
- 30° swivel L/R

AC-CB9320-258TV for swivel
AC-4180-0519-XE for Flat Panel Brackets (shown)

Keyboard Trays



AC-CBERGOTRY300

Full Extension Slides, Gel Palm Rest
And Rear Storage Compartments



AC-CBERGOTRY200

3/4 Extension Slides, Foam Palm Rest
Angled Keyboard

2109 Keyboard Slide



- 3/4 extension, 75lb load capacity
- Detent in and detent out
- Variable height mounting brackets
- Inboard or outboard mounting

AC-C2109-12D 12"
AC-C2109-14D 14"
AC-C2109-16D 16"
AC-C2109-18D 18"
AC-C2109-20D 20"

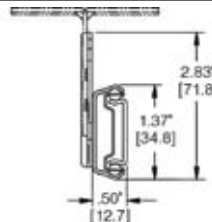

322 Shelf Slide



- Full extension 100lb Capacity
- Non-disconnect
- Tab mounting
- Requires .76" side space per side
- Designed for entertainment center shelves, appliance drawers and pan shelves.

AC-C322-14D 14"
AC-C322-16D 16"
AC-C322-18D 18"
AC-C322-20D 20"
AC-C322-22D 22"
AC-C322-24D 24"

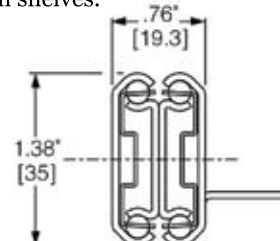

Accuride® ECLIPSE

- Front lever disconnect
- Faceframe and frameless compatible
- Full Extension 100lb load rating
- Vertical and Horizontal cam adjustment
- Optional rear face frame bracket provides 2" of depth adjustment



3132 Eclipse Self-Close Slide

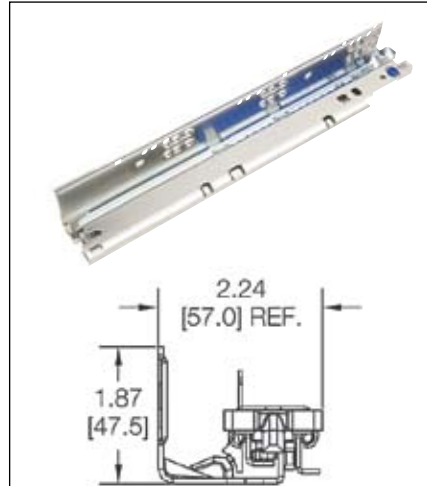

AC-C3132-12SC 12"
AC-C3132-12SCD BULK
AC-C3132-14SC 14"
AC-C3132-14SCD BULK
AC-C3132-16SC 16"
AC-C3132-16SCD BULK
AC-C3132-18SC 18"
AC-C3132-18SCD BULK
AC-C3132-20SC 20"
AC-C3132-20SCD BULK
AC-C3132-22SC 22"
AC-C3132-22SCD BULK
AC-C3132-24SC 24"
AC-C3132-24SCD BULK

3132 Eclipse Easy-Close Slide

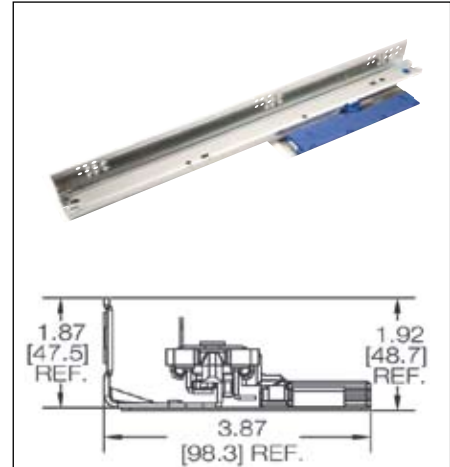

AC-C3132-12EC 12"
AC-C3132-12ECD 12" BULK
AC-C3132-14EC 14"
AC-C3132-14ECD 14" BULK
AC-C3132-16EC 16"
AC-C3132-16ECD 16" BULK
AC-C3132-18EC 18"
AC-C3132-18ECD 18" BULK
AC-C3132-20EC 20"
AC-C3132-20ECD 20" BULK
AC-C3132-22EC 22"
AC-C3132-22ECD 22" BULK
AC-C3132-24EC 24"
AC-C3132-24ECD 24" BULK



AC-4180-0568-XE
3132 Eclipse Series Drill Jig
Used to drill perfectly aligned mounting holes.



AC-4180-0603-XE
3132 Eclipse Series Drill Tool Kit

3132 Eclipse Series Hardware Kits



AC-4180-0559-XE, Individual
AC-4180-0587-XE, Bulk (6 per box)
Standard bottom mount disconnect



AC-4180-0584-XE
Optional vertical mount disconnect



AC-4180-0569-XE
Optional bottom mount brackets
Used when unable to side mount

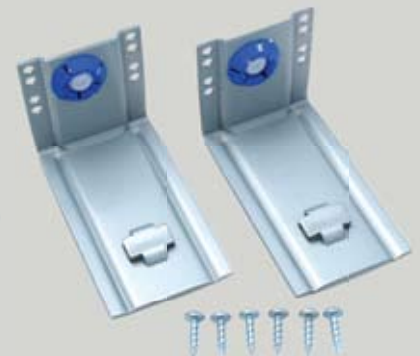

AC-4180-0560-XE
Rear Face Frame Brackets



110° Hinges



- H1074783 Ecomat Inset
- H9046807 Screw Inset
- H1030927 Pushin Inset
- H1030928 Blum Inset
- H1065087 Fix Inset

- H1074782 Ecomat Half OVL
- H1030619 Screw Half OVL
- H1030621 Pushin Half OVL
- H1065085 Fix Half OVL
- H1065086 Fix Blum Half OVL

125° Full Overlay



- H1058545 Screw
- H1058547 Pushin
- H1063462 Fix

Thick Door Hinge 32mm



- H1058371 95° Full OVL Pushin
- H073922 95° Inset Pushin

165° Hinges



- H1073371 Fix Full OVL
- H1073376 Fix Blum Full OVL
- H1076819 Screw Full OVL
- H1073310 Pushin Full OVL
- H1073385 Blum Full OVL
- H1073408 Flash Full OVL
- H1073407 Blum Half OVL
- H072964 Flash Half OVL

95° Full OVL Positive Hinges



- H1061848 Screw Pos 45°
- H079303 Flash Pos 45°
- H1063483 Fix Pos 45°
- H077694 Fix Pos 30°
- H077698 Blum Fix Pos 30°

Lazy Susan Door Hinge



- H1056243 Screw
- H1061930 Blum
- H1072716 Fix

Hinge Mounting Options

Screw-in Push-in Flash Fix



- Screw In - Screws Included
- Flash - Doweled Cam Lock
- Blum- Blum Hinge Pattern
- Push In- Dowels Mounted On Hinge
- Fix- Clamp Lock (Doweled Holes)

Optimat 3E 1 Piece 6-Way Face Frame Hinge



H9040499
1/2" OVL Push-in

H9046671
1-1/4" OVL Screw-on
H9040500
1-1/4" OVL Push-in

Faceframe Plate



H1076538 0mm Offset
H1076539 4.5mm Offset

Fascia Hinge with Spring System



H1019879
Panorama 95 column / flap hinge. For use in drop down
drawer fronts or entertainment center sides.

Eurocrew Hinge Plate



H1071625 0mm Offset
H1071627 3mm Offset
H1071629 8mm Offset
H1071745 0mm Cam Adj

Hettich Direkt



H1071665 0mm
H1071669 8mm

Offset screws to allow for back
to back hinge mounting with
3/4" wall material

Euro Box Plate



H1071605 0mm Offset
H1071725 0mm Cam Adj
H1071606 1.5mm Offset
H1071607 3mm Offset
H1071727 3mm Cam Adj
H1071608 5mm Offset
H1071609 8mm Offset
H077946 11mm Offset

Hinge Silent Close



H9015112 Clip-on Silent System



H9015115 Screw-in Silent System



Hinge Adapter Plate



H1074730 5° Angle
H1074727 3mm Spacer

Quadro IW 20 Full-Extension Slide



- 100lb Load Capacity
- Self-Close, spring-operated mechanism that acts independently of load
- Slide-on assembly for easy installation
- Resilient tracks with optimal runner action and precision-guided steel ball bearings
- Flexibility when swapping the Quadro partial and Full extension runners without changing cabinet, Drawer or front panel dimensions.

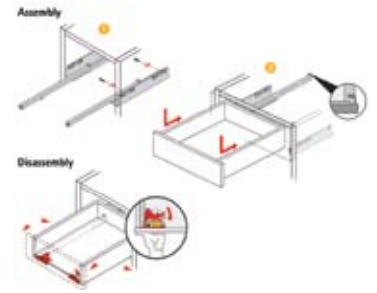

H113124500	280mm Quadro IW20
H113125100	300mm Quadro IW20
H113125200	350mm Quadro IW20
H113125300	400mm Quadro IW20
H113125300	400mm Quadro IW20
H113125400	450mm Quadro IW20
H113124400	500mm Quadro IW20
H113125500	550mm Quadro IW20
H113125600	600mm Quadro IW20



H3103737002
Quadro Rear Attachment Clip

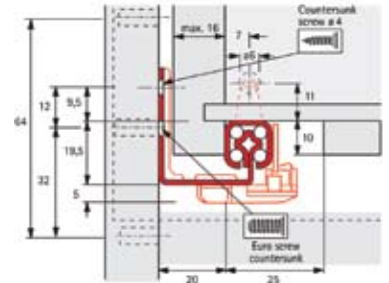

Flush OVL Hinges

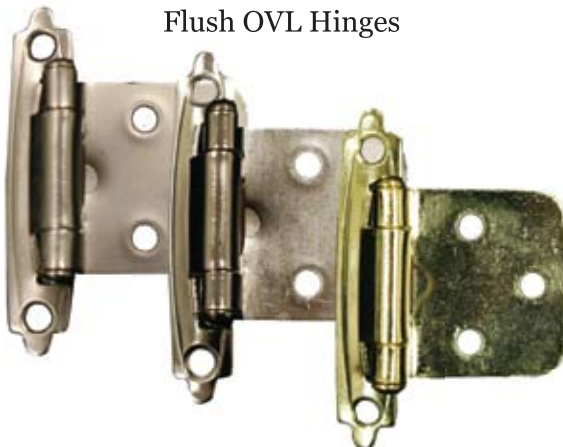

L-H0103BC-SN	Satin Nickle OVL Hinge
L-H0103B-CHR-A	Chrome OVL Hinge
L-H0103B-BP-A	Brass OVL Hinge

White Epoxy Partial Extension Slide



Style 302 75lb Rating
H1083320 18"
H1083321 20"
H9006351 22"

Style 402 100lb Rating
H1056073 20"
H1056079 22"

H33406480 Rear Boots
For 302 and 402 Slides

3/8 Inset Hinges

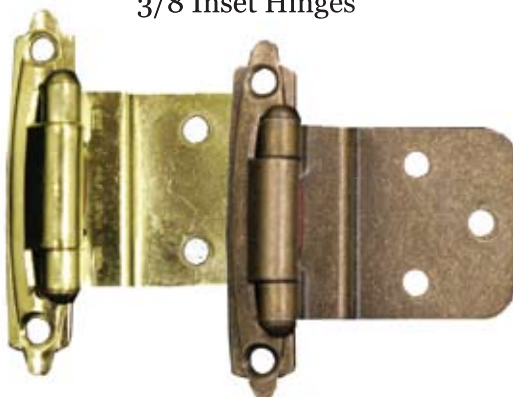

L-H0104A-BP-A	Brass Inset Hinge
L-H0104A-AB-A	Anitque Brass Inset Hinge

Hinge Boring Machine Accessories



Replacement Hinge Drill Bit
For Hinge Drilling Machine

H053955 35mm
H069250 40mm



Replacement Left-hand
Bit For Hinge Drilling Machine

H053951 10mm (Hettich)
H053818 8mm (Blum)



Drive & Insert Bits
#1 & #2 Phillips
 SC-BIT-PH1X2.75"
 SC-BIT-PH2X1"
 SC-BIT-PH2X2"
 SC-BIT-PH2X3.5"
 SC-BIT-PH2X6"



#2 Square Drive
 SC-BIT-SQ2X1"
 SC-BIT-SQ2X2"
 SC-BIT-SQ2X4"
 SC-BIT-SQ2X6"



Fillister Square Drive Type 17
Face Frame Deep & Fine Thread
#6 X 1-1/4" Yellow Zinc
 SC-FL-125DB Deep 10000/CASE
 SC-FL-125DM Deep 1000/PACK
 SC-FL-125FB Fine 10000/CASE
 SC-FL-125FM Fine 1000/PACK

#6 X 1-1/2" Yellow Zinc
 SC-FL-150DB Deep 8500/CASE
 SC-FL-150DM Deep 1000/PACK
 SC-FL-150FB Fine 8500/CASE
 SC-FL-150FM Fine 1000/PACK



Flat Square Drive Type 17 Nibbed

#8 Zinc Finish
 SC-FS-100ZB 1" 12000/CASE
 SC-FS-100ZM 1" 1000/PACK
 SC-FS-112ZB 1-1/8" 11000/CASE
 SC-FS-112ZM 1-1/8" 1000/PACK
 SC-FS-125ZB 1-1/4" 10000/CASE
 SC-FS-125ZM 1-1/4" 1000/PACK
 SC-FS-150ZB 1-1/2" 8500/CASE
 SC-FS-150ZM 1-1/2" 1000/PACK
 SC-FS-162ZB 1-5/8" 7000/CASE
 SC-FS-162ZM 1-5/8" 1000/PACK
 SC-FS-175ZB 1-3/4" 6000/CASE
 SC-FS-175ZM 1-3/4" 1000/PACK
 SC-FS-200ZB 2" 1000/PACK
 SC-FS-250ZB 2-1/2" 3500/CASE
 SC-FS-250ZM 2-1/2" 1000/PACK
 SC-FS-300ZB 3" 2500/CASE
 SC-FS-300ZM 3" 1000/PACK



Drawer Front Philips Drive
#8 Zinc Finish
 SC-TM-112ZB 1-1/8" 6500/CASE
 SC-TM-112ZM 1-1/8" 1000/PACK
 SC-TM-125ZB 1-1/4" 6500/CASE
 SC-TM-125ZM 1-1/4" 1000/PACK



Flat Head Type 17 Nibbed

#8 Black Oxide Finish-Square Drive

SC-FS-100BB 1" 12000/CASE
 SC-FS-100BM 1" 1000/PACK
 SC-FS-112BB 1-1/8" 11000/CASE
 SC-FS-112BM 1-1/8" 1000/PACK
 SC-FS-125BB 1-1/4" 10000/CASE
 SC-FS-125BM 1-1/4" 1000/PACK
 SC-FS-150BB 1-1/2" 8500/CASE
 SC-FS-150BM 1-1/2" 1000/PACK
 SC-FS-162BB 1-5/8" 7000/CASE
 SC-FS-162BM 1-5/8" 1000/PACK
 SC-FS-175BB 1-3/4" 6000/CASE
 SC-FS-175BM 1-3/4" 1000/PACK
 SC-FS-200BB 2" 1000/PACK
 SC-FS-250BB 2-1/2" 3500/CASE
 SC-FS-250BM 2-1/2" 1000/PACK
 SC-FS-300BB 3" 2500/CASE
 SC-FS-300BM 3" 1000/PACK

#8 Black Oxide Finish-Combo Drive

SC-FC-100BB 1" 10000/CASE
 SC-FC-100BM 1" 1000/PACK
 SC-FC-125BB 1-1/4" 7500/CASE
 SC-FC-125BM 1-1/4" 1000/PACK
 SC-FC-150BB 1-1/2" 6500/CASE
 SC-FC-150BM 1-1/2" 1000/PACK
 SC-FC-250BB 2-1/2" 3000/CASE
 SC-FC-250BM 2-1/2" 1000/PACK
 SC-FC-300BB 3" 2000/CASE
 SC-FC-300BM 3" 1000/PACK

#8 Black Oxide Finish-Philips Drive

SC-FP-100BM 1" 1000/PACK
 SC-FP-125BM 1-1/4" 1000/PACK
 SC-FP-150BM 1-1/2" 1000/PACK
 SC-FP-175BM 1-3/4" 1000/PACK
 SC-FP-200BM 2" 1000/PACK
 SC-FP-250BM 2-1/2" 1000/PACK
 SC-FP-300BM 3" 1000/PACK



Knobs and Pulls
 8/32X1-1/8" Phillips Slot Head
 SC-TP-112ZB 6500/CASE
 SC-TP-112ZM 1000/PACK



Knobs and Pulls (Breakaway)
 8/32X1-3/4" Phillips Slot Head
 SC-TP-175ZB 4000/CASE
 SC-TP-175ZM 1000/PACK



Washer Head Square Drive Type 17

#8 Zinc Finish
 SC-WS-100ZB 1" 8000/CASE
 SC-WS-100ZM 1" 1000/PACK
 SC-WS-112ZB 1-1/8" 7000/CASE
 SC-WS-112ZM 1-1/8" 1000/PACK
 SC-WS-125ZB 1-1/4" 6000/CASE
 SC-WS-125ZM 1-1/4" 1000/PACK
 SC-WS-150ZB 1-1/2" 5000/CASE
 SC-WS-150ZM 1-1/2" 1000/PACK
 SC-WS-175ZB 1-3/4" 4500/CASE
 SC-WS-175ZM 1-3/4" 1000/PACK
 SC-WS-200ZB 2" 4000/CASE
 SC-WS-200ZM 2" 1000/PACK
 SC-WS-250ZB 2-1/2" 2500/CASE
 SC-WS-250ZM 2-1/2" 1000/PACK
 SC-WS-300ZB 3" 1800/CASE
 SC-WS-300ZM 3" 1000/PACK



Hardware Type A
#8 Zinc Finish Phillips #1 Head
 SC-FT-043ZM 7/16" 1000/PACK

Hardware

#6 Nickel Finish Phillips Head
 SC-FP-050NM 1/2" 1000/PACK
 SC-FP-062NM 5/8" 1000/PACK
 SC-FP-062NM 5/8" 20000/CASE
 SC-FP-075NM 3/4" 1000/PACK
 SC-FP-100NM 1" 1000/PACK

#5 Antique Brass
 SC-OWS-062ABM 5/8" 1000/PACK
 SC-OWS-050ABM 1/2" 1000/PACK

#5 Bright Brass
 SC-OWS-062BBM 5/8" 1000/PACK

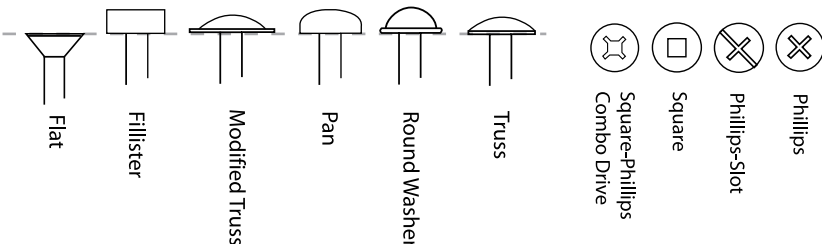

Type 17 Point



Nibbed Flat Head

Design Facets

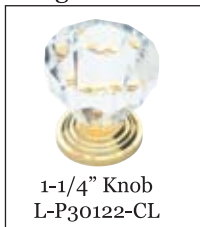

1-1/4" Knob
L-P30122-CL

Coastal

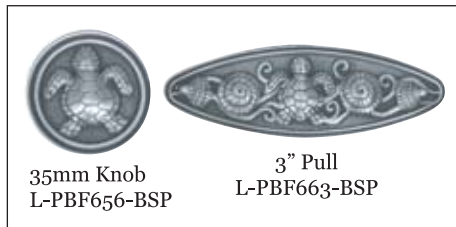

35mm Knob
L-PBF656-BSP

3" Pull
L-PBF663-BSP

French Romantics



38mm Knob
L-PN1738-ABT
L-PN1738-BSP

38mm Knob
L-PN1513-ABT
L-PN1513-BSP

40mm Knob
L-PBF140-ABT
L-PBF140-BSP

38mm Knob
L-PN1291-ABT
L-PN1291-BSP

Bauhaus



L-P02103-SS 288/368mm Pull
L-P02102-SS 224/304mm Pull
L-P02164-SS 64/115mm Pull
L-P02140-SS 40mm Bar Knob

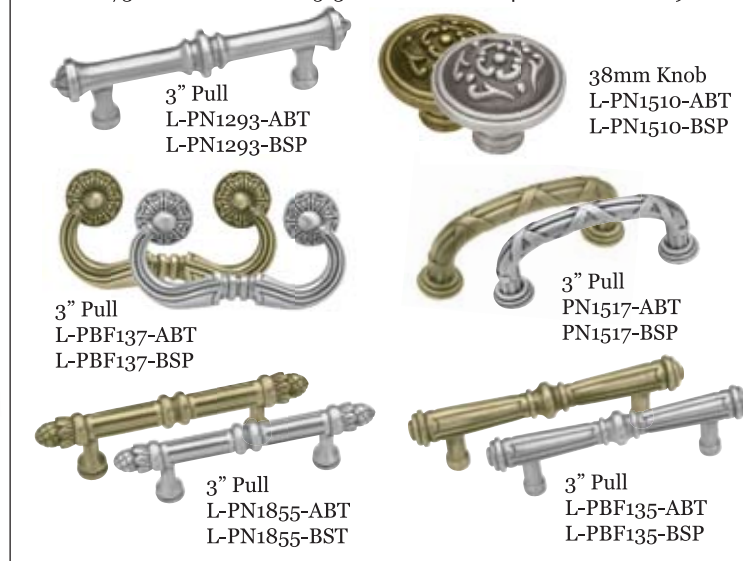

3" Pull
L-PN1293-ABT
L-PN1293-BSP

38mm Knob
L-PN1510-ABT
L-PN1510-BSP

3" Pull
L-PBF137-ABT
L-PBF137-BSP

3" Pull
PN1517-ABT
PN1517-BSP

3" Pull
L-PN1855-ABT
L-PN1855-BST

3" Pull
L-PBF135-ABT
L-PBF135-BSP

Sophisticates II

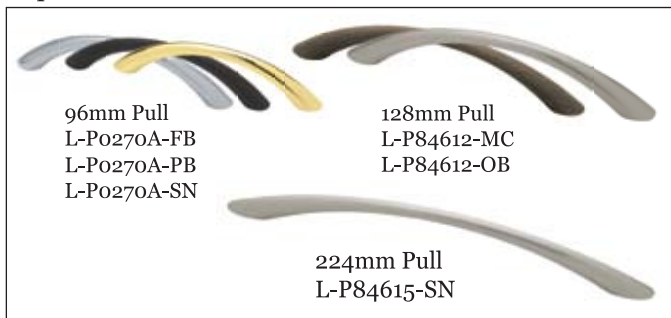

96mm Pull
L-P0270A-FB
L-P0270A-PB
L-P0270A-SN

128mm Pull
L-P84612-MC
L-P84612-OB

224mm Pull
L-P84615-SN

Contempo II



30mm Knob
L-P84302-OB

30mm Knob
L-PN0416-OB
L-PN0416-SN

35mm Knob
L-PN0407-OB
L-PN0407-SN

30mm Knob
L-PN0523-OB
L-PN0523-SN

96mm
L-PN0533-OB
L-PN0533-SN

Forged Iron



124mm Knob
L-PN1780-OB
L-PN1780-VBR

50mm Knob
L-PN0528-FB
L-PN0528-AP

64mm Knob
L-P0528A-FB
L-P0528A-VBR
L-P0528A-AP

Circles & Scrolls



3" Pull
L-PBF508-BSP

Forged Iron II

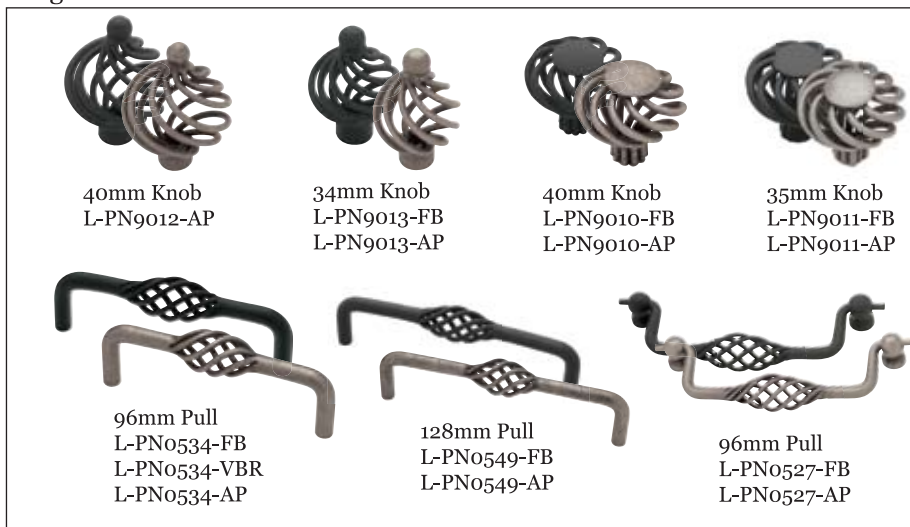

40mm Knob
L-PN9012-AP

34mm Knob
L-PN9013-FB
L-PN9013-AP

40mm Knob
L-PN9010-FB
L-PN9010-AP

35mm Knob
L-PN9011-FB
L-PN9011-AP

96mm Pull
L-PN0534-FB
L-PN0534-VBR
L-PN0534-AP

128mm Pull
L-PN0549-FB
L-PN0549-AP

96mm Pull
L-PN0527-FB
L-PN0527-AP

Rustique

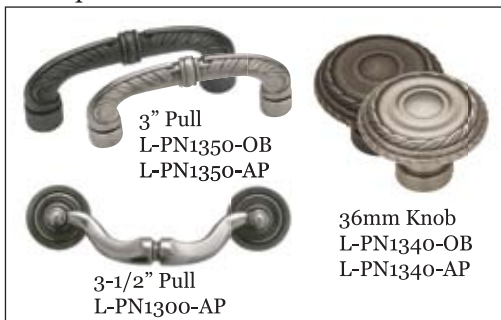

3" Pull
L-PN1350-OB
L-PN1350-AP

36mm Knob
L-PN1340-OB
L-PN1340-AP

3-1/2" Pull
L-PN1300-AP

Mission Styles

Pull PN0746-MIB
3-1/4" Backplate
L- PN0046-MIB

76mm Pull
L-PN0024-PEW

Pull L-PN0745-MIB
4-1/2" Backplate
L-PN0045-MIB

Cup Pulls

64mm Cup Pull
L-PN1053-BSN

64mm Cup Pull
L-PN0601-SN
L-PN0601-OB

Belmont

96mm Pull
L-PN6492-SS

30mm Knob
L-PN6501-SS

Suburban

96mm Pull
L-P84216-SN
L-P84216-OB

128mm Pull
L-P84217-SN
L-P84217-OB

Hooks

L-B46305-SN

Modern Cable

30mm Knob
L-PN0408-OB
L-PN0408-SN

30mm Knob
L-PN0397-OB
L-PN0397-PB

Individuals

37mm Knob
L-PN0401-SN
L-PN0401-BST
L-PN0401-PB

28mm Knob
L-PN0461-SN
L-PN0461-PB

30mm Knob
L-P84061-SN

25mm Knob
L-PN0398-OB

24mm Knob
L-PN0399-OB
L-PN0399-SN

35mm Knob
L-PN0624-PB

30mm Knob
L-PN0409-RAL
L-PN0409-SN

30mm Knob
L-PN0292-SN

36mm Knob
L-PN0836-BSN

1-1/2" Knob
L-P95715-W

1-1/4" Knob
L-P95712-W

1-1/4" Knob
L-P26055-PL

1-1/4" Knob
L-P50154-CHR-A
L-P50154C-FB-C
L-P50154-STN-A
L-P50154-PB-A

1-1/4" Knob
L-P50150-BLC-A
L-P50150-OB
L-P50150-PB

3" Pull
L-P39955-SN

3" Oak Pull
H45012783

Fusilli II

26mm Knob
L-PN0394-OB
L-PN0394-SN
L-PN0394-BST

30mm Knob
L-PN0395-OB
L-PN0395-PB
L-PN0395-SN
L-PN0395-BST

35mm Knob
L-PN0393-BST
L-PN0393-OB
L-PN0393-PB

96mm Pull
L-P83506-SN
L-P83506-OB

Hammered Metal

64mm Pull
L-P59074-BZA
L-P59074-RAL

34mm Knob
L-P59059-BZA
L-P59059-RAL

Finishes

Plated Brass (PB)

Tumbled Antique Brass (ABT)

Bronze Antique (BZA)

Oil Rubbed Bronze (OB)

Brushed Sterling Silver (BST)

Brushed Satin Nickel (BSN)

Sterling Silver (SS)

Satin Nickel (SN)

Brushed Satin Pewter (BSP)

Antique Pewter (AP)

Mission Black (MIB)

Flat Black (FB)

Appliance Garages



AG-100CSR Tambour Garage

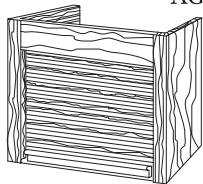

Square Appliance Garage

- ON-AG-100SSM-18 Maple 18"
- ON-AG-100SSR-18 Red Oak 18"
- ON-AG-100SSC-24 Cherry 24"
- ON-AG-100SSM-24 Maple 24"
- ON-AG-100SSR-24 Red Oak 24"

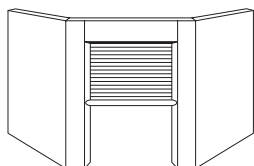

Corner Appliance Garage

- ON-AG-100CSAL Alder
- ON-AG-100CSC Cherry
- ON-AG-100CSM Soft Maple
- ON-AG-100CSR Red Oak

Tambour Accessories



Tambour Tracks

- ON-ST2-16AL 16" Track Spring System
- ON-ST2-24AL 24" Track Spring System

V-3 Veneer Wood Tambours

47-1/2 X 36"

- ON-V3-AL501 Alder
- ON-V3-CH520 Cherry
- ON-V3-HI509 Hickory
- ON-V3-MA501 Maple
- ON-V3-RO502 Red Oak



SW-30 Solid Wood Tambours

47 X 36 X 3/16"

- ON-SW30-AL503 Alder
- ON-SW30-CH514 Cherry
- ON-SW30-HI506 Hickory
- ON-SW30-MA508 Maple
- ON-SW30-RO513 Red Oak



Wine Bottle Lattice



Wine Bottle Lattice 24 X 30"

- GH-WINE-2430CH Cherry
- GH-WINE-2430SM Maple
- GH-WINE-2430RO Red Oak

Wine Bottle Lattice 24 X 43"

- GH-WINE-2443CH Cherry
- GH-WINE-2443SM Maple
- GH-WINE-2443RO Red Oak

GH-WINECUSTOM Custom size wine lattice
Minimum 5 sqft charge domestic specie only
Lattice will be built 1-2" oversize
5-7 day lead time

GH-WINEECUSTOM Custom size embossed wine lattice
Minimum 5 sqft charge Maple and Cherry only
Lattice will be built 1-2" oversize
5-7 day lead time



Leaf Embossed Wine Bottle Lattice in Maple

- GH-WINE-2430ESM 24 X 30"
- GH-WINE-2443ESM 24 X 43"
- GH-WINE-2430ECH 24 X 30"
- GH-WINE-2443ECH 24 X 43"



Plate Rack



Plate Rack 13-1/16" X 36"

- ON-NPD-36-CH Cherry
- ON-NPD-36-MA Maple
- ON-NPD-36-RO Red Oak

Stemware Rack



- GH-STEM30-CH Cherry 11-1/4 X 30"
- GH-STEM36-CH Cherry 11-1/4 X 36"
- GH-STEM30-SM Maple 11-1/4 X 30"
- GH-STEM36-SM Maple 11-1/4 X 36"
- GH-STEM30-RO Red Oak 11-1/4 X 30"
- GH-STEM36-RO Red Oak 11-1/4 X 36"
- GH-STEMCUSTOM Custom Length/Width
Minimum 3 sqft.

Spindle/Galley Rail



Spindle Rail With Lip 8" X 2-1/2"

- ON-SPRL-WL-CH Cherry
- ON-SPRL-WL-MA Maple
- ON-SPRL-WL-RO Red Oak

Cutlery Drawer Inserts



GH-INSRT-CT15
 15-1/8 X 22 X 2-7/8" Cutlery Drawer Insert
 2-3/8" Inside spacing between compartments,
 Made from Maple, Clear Coat finish,
 Can be cut down to 8-3/4" wide.



GH-INSRT-CT20
 20-5/8 X 22 X 2-7/8" Cutlery Drawer Insert
 2-3/8" Inside spacing between compartments,
 Made from Maple, Clear Coat finish,
 Can be cut down to 14-5/8" wide.

Utensil Drawer Inserts



GH-INSRT-UT18
 18-1/2 X 22 X 2-7/8" Utensil Drawer Insert
 3-1/2" Inside spacing between compartments,
 Made from Maple, Clear Coat finish,
 Can be cut down to 8-1/8" wide.



GH-INSRT-UT24
 24 X 22 X 2-7/8" Utensil Drawer Insert
 3-1/2" Inside spacing between compartments,
 Made from Maple, Clear Coat finish,
 Can be cut down to 12-1/8" wide.

Spice Rack Drawer Insert



GH-INSRT-SP18 18 X 19-3/4 X 1-1/2"
GH-INSRT-SP24 24 X 19-3/4 X 1-1/2"

Made from Maple, Clear Coat finish.

Custom Pot Rack Drawer Box



GH-DRAWER-POT

Offered in standard 21" depth and 24" height with custom width. Bullnosed upper shelves are rabbetted at 5 degree angle into solid maple sides. Bottom and back panels are 1/2" plywood. 5-7 day lead time, clear coat finishing available.



Scalea or Saphir?

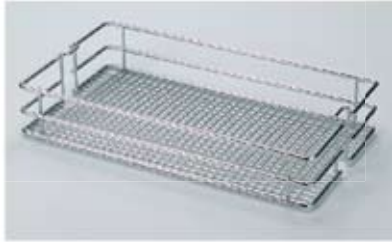

Saphir chrome plated



Scalea silver powder coat with maple



HSA Cabinet Pull-Out

The HSA Cabinet Pull-Out System features a full-extension slide with the E-Z Close Dampening System. It also has variable frame heights from 650mm to 2150mm, an adjustable basket assembly and three dimensional door front adjustment. 250lbs. capacity.

4 Basket Systems Are For Cabinets 57 To 67" Tall
5 Basket Systems Are For Cabinets 75 To 84" Tall

- 11" Wide 4 & 5 Basket
- F-HSA4-11SAPHIR
- F-HSA6-11SAPHIR
- F-HSA4-11SCALEA
- F-HSA6-11SCALEA

- 14" Wide 4 & 5 Basket
- F-HSA4-14 SAPHIR
- F-HSA6-14 SAPHIR
- F-HSA4-14 SCALEA
- F-HSA6-14 SCALEA

- 19" Wide 4 & 5 Basket
- F-HSA4-19 SAPHIR
- F-HSA6-19 SAPHIR
- F-HSA4-19 SCALEA
- F-HSA6-19 SCALEA

DSA Narrow Cabinet System

The DSA Cabinet Pull-Out System is designed for tall narrow cabinets and features a very flexible application with the E-Z-Close Dampening System. For straight 90 degree door fronts and angled door fronts 35 and 45 degrees. Door front brackets are 3-way adjustable. 150lbs Capacity. Available in Saphir and Scalea basket design. Use the 2 frame for 23" cabinet height and 3A frame for 26.65" cabinet height. Special order frames are available up to 72" in height.

F-DSA-2FRAME
F-DSA-3AFRAME

- 3" Wide Basket 90 Degrees
- F-DSA-85-SAPH
- F-DSA-85-SCAL
- F-DSA-SHEET

- 5" Wide Basket 90 Degrees
- F-DSA-125-SAPH
- F-DSA-125-SCAL

- 6-1/2" Wide Basket 90 Degrees
- F-DSA-165-SAPH
- F-DSA-165-SCAL

- 9" Wide Basket 90 Degrees
- F-DSA-230-SAPH
- F-DSA-230-SCAL



Cookie Sheet Holder



Waste Basket Pullout

The Waste Basket Pull-Out System incorporates the self-closing and slam-resistant E-Z Close feature with a durable 175lb capacity slide. It also features with a vacuum formed tray that is designed to cradle the waste bin. Designed to fit 14-3/4" to 18-3/4" width cabinet openings. Front mounting clips offer 6 way adjustments for cabinet door.

- F-FR3610
- F-TRASHCAN WHT
- F-TRASHCAN BIS



Twin Corner

Twin corner base cabinet and blind cabinet swing out system is a unique solution for the corner cabinet problem. Capable of supporting 100 lbs., both shelves swing simultaneously out of the cabinet for easy reach. Three sizes available in both left hand and right hand models. 36-42" is total depth of cabinet with a minimum door opening of 16.18" for the 36" model; 18.15" for the 39" model and 22.09" for the 42" model.

- F-TC-914MMLEFT 36"
- F-TC-914MMRIGHT 36"
- F-TC-991MMLEFT 39"
- F-TC-991MMRIGHT 39"
- F-TC-1067MMLEFT 42"
- F-TC-1067MMRIGHT 42"

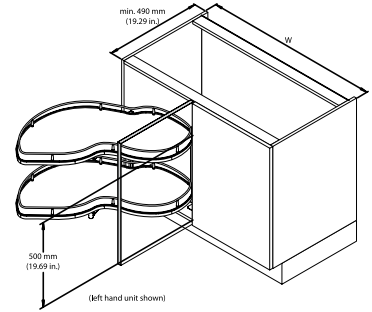

Lazy Susan

Lazy Susans are available in pie cut corner and full circle versions with scalea tray. Pie cut tray models are available as special order. Adjustable center tube accommodates 26.77" to 29.99" cabinet heights. Use the full circle model on diagonal cabinets with hinged door. Pie cut model for corner cabinets with double hinged door. All lazy susan models have a 150 lb capacity.

Pie Cut Lazy

- F-PCB-720MAPLE (28.35")
- F-PCB-820MAPLE (32.28")

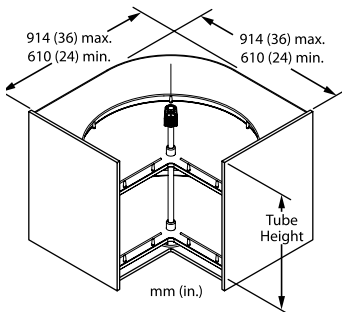

Full Circle Lazy Susan

- F-LS-820MAPLE (32.28")

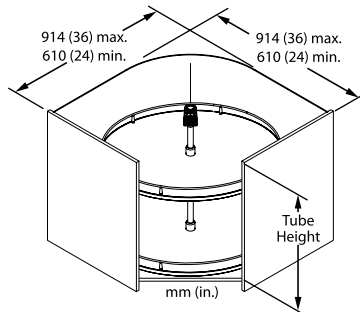

Lazy Susan Auto Retract

An ingenious solution to the diagonal base corner cabinet. This mechanism pulls the door in when pushed on then with a left or right swing the door revolves inside the cabinet. When the lazy susan reaches the self centered closed detent position, auto retract triggers to return the door to its home position. Please visit our showroom for an installed display of this innovative product. This model is capable of supporting 150 lbs. and requires 3/4" dropped floor to allow for door to revolve inside cabinet. The optional basket kit is the small trays behind autoretract mechanism.

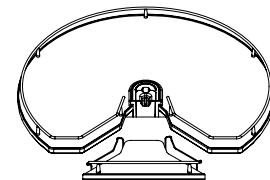
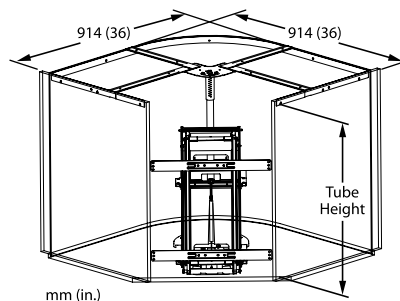

- F-LSC-DOORMECH
- F-LSC-810MAPLE (2 shelves)

- Optional
- F-LSC-BASKET (2 baskets)

www.gahwd.com



New!

Gothic 7-Lite Glass Door

Distributors and Manufacturers
of Premium Cabinet Components.



Georgia Hardwoods Inc
P.O. Box 504 Buford, GA 30515
800-992-6426 ▪ 770-932-0640 ▪ Fax:770-932-0651