

STRIPLOX™

SIMPLE, STRONG, SECURE

The perfect hanging and joining solution



PERFECT FOR

Kitchens & Bathrooms
Cabinetry
Architectural Projects
Commercial Design
Furniture Manufacture
Retail Space
Signage
Exhibitions & Displays
Wardrobes/Closets
RV & Marine
Feature Wall & Ceiling Panels
Acoustic Timber Walls & Ceilings

Amazing results

Striplox makes every unique joining application streamlined and concealed for use on solid timber, MDF, composite panels, aluminium features, balsa wood plus more. Striplox is easy to install, fully adjustable, highly customisable and made from environmentally friendly, durable, heat stabilized glass reinforced nylon. With unparalleled strength Striplox will meet all required needs in numerous applications.

Aesthetically, Striplox replaces visible screws, brackets, fittings, connectors, latches, cam and dowels, mounting blocks and other mechanical components providing leading edge design solutions.

Striplox can be surface or rebate mounted in either vertical or horizontal positions.

- Simple
- Strong
- Secure

Striplox Pro 23

The Striplox Pro 23 connectors have been designed for literally hundreds of uses, from large scale architectural projects through to custom design features.

The Striplox Pro 23 is ideal for installing modern timber battens, hanging cabinets, floating shelves, bookcases, artwork

frames, mirrors and feature panels. It achieves the results you want with bespoke furniture with its narrow profile for tidy concealment. You will be amazed with its strength, versatility and varied range of uses.

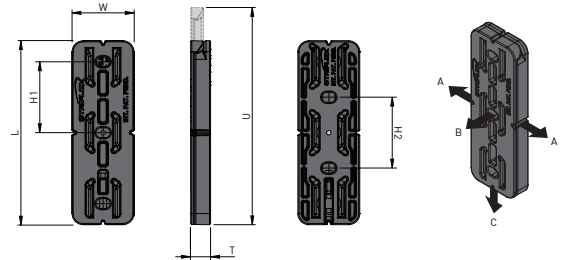

Units	Dimensions						Indic. Load Capacity		
	W	L	T	U	H1	H2	A	B	C
Metric (mm/kg)	28	83	9	98	32	32	110	95	160
Imperial (in/lb)	1.10	3.27	0.35	3.86	1.26	1.26	242	209	352

Striplox Pro 55

The Striplox Pro 55 connectors are the same design as the Pro 23 but with a larger size for extra heavy duty requirements. With a larger load capacity, you can achieve leading edge designs with architectural projects, furniture designs,

exhibition displays through to bathroom, kitchen and office builds and installations. Create unique key design elements such as feature batten ceiling designs, mantle piece installations plus numerous structural innovations. The re-useable capabilities of the Pro 55 provide endless possibilities.

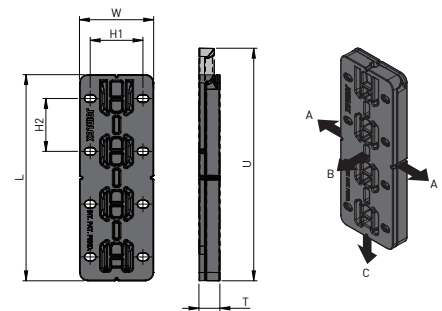

Units	Dimensions						Indic. Load Capacity		
	W	L	T	U	H1	H2	A	B	C
Metric (mm/kg)	45	126	12.8	142	32	32	200	106	200
Imperial (in/lb)	1.77	4.96	0.5	5.59	1.26	1.26	440	233	440

Striplox Clip 50

The Striplox Clip 50 is designed with some smaller precise applications in mind, this versatile and strong connecting system can be used in the tightest of places quickly and efficiently in commercial, architectural or domestic



applications. The Striplox Clip 50 offers an advantage when being used on a less than perfectly square wall with its unique locking system and the option of permanent or reusable assembly. The locking key can also swivel for easy positioning.

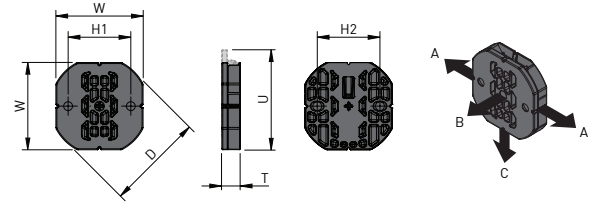

Units	Dimensions						Indic. Load Capacity		
	W	D	T	U	H1	H2	A	B	C
Metric (mm/kg)	44.5	49.5	9.5	51	32	32	95	95	125
Imperial (in/lb)	1.75	1.95	0.37	2	1.26	1.26	209	209	275

Striplox Mini 60

The Striplox Mini 60 connectors are an invisible joiner suited to everyday builds, custom cabinets, wood joints and anywhere else you commonly use biscuit joints, fasteners or cam and dowel products. The Striplox Mini 60 creates a

tight, neat, fully concealed solution that can be a permanent or fully reusable joint every time. The Mini 60 uses existing methods for installation with no specialised tools required, delivering a fast, strong assembly of components or panels.

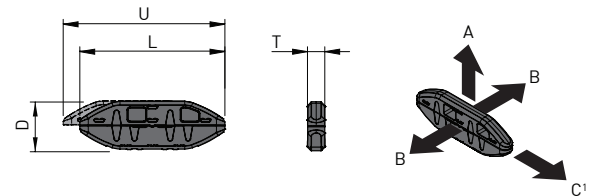

Units	Dimensions						Indic. Load Capacity		
	D	L	T	U	H1	H2	A	B	C ¹
Metric (mm/kg)	20	60	7	67.4	-	-	90	100	80
Imperial (in/lb)	0.79	2.36	0.276	2.65	-	-	198	220	176

¹ In direction of lock-up.

Striplox Mini 120

The Striplox Mini 120 connectors enable a rapid assembly with a fully concealed joining and fastening solution to any piece of cabinetry, furniture or design application. The Striplox Mini 120 connectors produce a tight and strong

joint either in a permanent or reversible configuration making them perfectly suited for commercial, domestic and architectural furniture, kitchen, bathroom and wardrobe closets, cabinetry, commercial fit-outs plus many more applications.

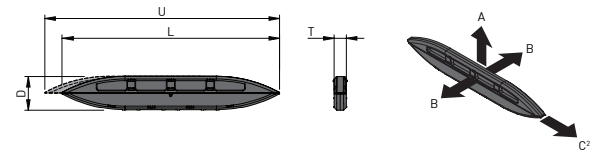

Units	Dimensions						Indic. Load Capacity		
	D	L	T	U	H1	H2	A	B	C ²
Metric (mm/kg)	19.5	124	7	135	-	-	200	146	119
Imperial (in/lb)	0.77	4.88	0.276	5.31	-	-	440	322	262

² In direction of lock-up.

Striplox 90D 98

The Striplox 90D 98 is an innovative engineered solution designed to quickly and easily connect any right angle joints. It is ideal for common joints including mitre joints, butt joints, T joints, square joints, frame joints and flush joints.

The Striplox 90D 98 is the must use connector for achieving the highest level of satisfaction. The Striplox patented design pulls the substrates firmly together to form a strong and tight joint in one simple action by distributing the loads evenly over the entire connector and joint.

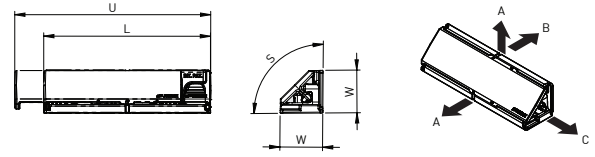

Units	Dimensions						Indic. Load Capacity		
	W	L	S	U	H1	H2	A	B	C
Metric (mm/kg)	25	98	90°	115	32	32	200	66	200
Imperial (in/lb)	0.98	3.86	90°	4.53	1.26	1.26	440	145	440

Striplox 180D

The Striplox 180D is incredibly strong and easy to use in one action. Imagine adding tables together in seconds at conference venues and restaurants! It will join almost any 180 degree joint in numerous applications. Create custom made boardroom, conference, kitchen

and benchtop tables, workstations, retail fixtures and large scale exhibition displays. The Striplox 180D creates perfect paneling and signage and can be used on postform or solid materials.

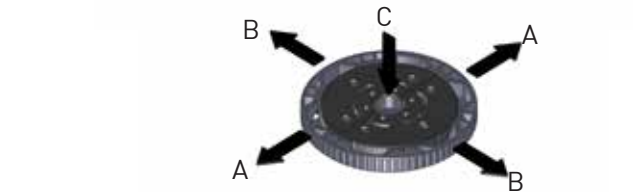
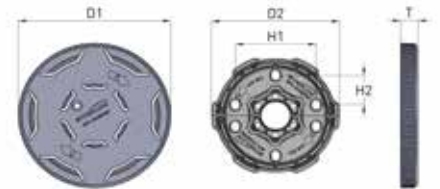

Units	Dimensions					Indic. Load Capacity		
	D1	D2	H1	H2	T	A	B	C
Metric (mm/kg)	114.3	96	60.5	23.3	13	200	230	200
Imperial (in/lb)	4.5	3.78	2.38	0.92	0.51	440	507	440

Striplox Megalox

The simple to use, ultra strong, Striplox Megalox is ideal for bench and table top installations of mitre joint, T joint or box joints. You can design office partitioning exactly to your unique specifications. The Striplox Megalox is the perfect solution for office, bathroom, furniture, toilet partitions and

locker room installations and manufacturing. Benchtop Waterfalls and custom designed kitchen benches can be created with ease and no time delays waiting for glues to dry. The Striplox Megalox is a convenient (RTA) system that enables flat packing for easy transportation.

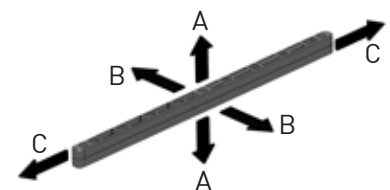
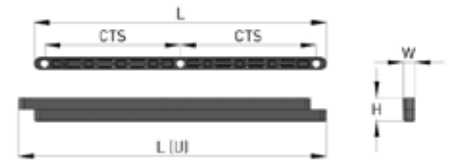

Units	Dimensions					Indic. Load Capacity		
	L	L (w)	CTS	H	W	A	B	C
Metric (mm/kg)	241	254	112	19	9.5	150	295	160
Imperial (in/lb)	9.49	10	4.41	0.748	0.374	330	650	352

Striplox Griplex No 20 Biscuit

The Striplox No 20 grip Biscuit makes the 'doing' a whole lot easier and enjoyable. Traditional wood biscuits lose their shape and swell up in atmospheric conditions, resulting in substrate blowout. The Striplox No 20 grip Biscuit is the new solution. It will never lose shape,

and its innovative gripping spikes secure your project in place, providing a superior result every time. All you need is a hammer to knock it in saving time in clamping and eliminating the endless wait for glue to dry.

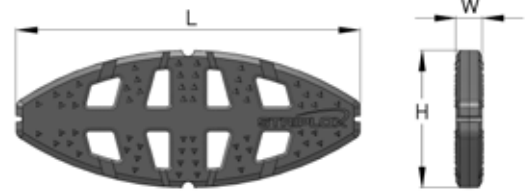

Units	Dimensions		
	W	L	H
Metric (mm/kg)	4.25	56	23
Imperial (in/lb)	0.167	2.2	0.9

Striplox Accessories



The Striplox Accessories range can be used with the range of innovative Striplox assembly solutions to save you time and money.

Liquidlox

Liquidlox is a general purpose, middle viscosity, high strength fast cure adhesive compatible with all Striplox assembly products and a wide range of substrates.

Striplox Cutters & Routers

The Striplox Cutters and Routers produce an accurate and reliable positioning for the entire Striplox range.

Striplox Mark-Out Template

The Striplox Mark-Out Template speeds up the manufacturing processes by enabling the easy fits of the Striplox range of joining solutions.

Striplox Jigs

The range of Striplox Jigs aid installation to save time during fitment by accurately marking fixing center points.

Visit our Facebook page, website and YouTube Channel to upload our latest product literature.



Visit: <https://www.facebook.com/striplox>



STRIPLOX™



www.joinlox.com/striplox



Striplox products are designed and tested for a range of applications. Product use is subject to variable materials and conditions. Technical information and load capacities are a guide only without warranty and Joinlox will not be liable for any subsequent damage or loss from the use of the products or this information.

Joinlox
2/30 Walker Street,
Tennyson Brisbane QLD 4105,
Australia
+61 7 3392 6172
striplox@joinlox.com

Available Worldwide



Disponibile International
Disponibile Internacionalmente
Erhältlich International
Disponibile In Tutto Il Mondo
利用可能なワールドワイド
全球販売



Striplox™ and Joinlox® are trademark and patent protected internationally.

Striplox New Brochure Version PRINTERS SINGLES Final 16 03 17